

RADIO'S LIVEST MAGAZINE



Sept  
25 Cents

# Radio-Craft

1931

HUGO GERNSBACK Editor

*How to test Pentodes*

**The Radio  
"Sherlock Holmes"**

See Page 140



The "RADIO-CRAFT" A. C. Pentode Portable—A Short-Wave Converter for D. C. Operation  
Design of Power Transformers—Characteristics of the Pentodes—Going After Service.

# NEW **SPEED** TUBES

## FOR ALL NEW RECEIVERS

EVER ABREAST OF THE RADIO TIMES

**235**

New screen grid tube—designed to reduce cross modulation and similar distortion.

**551**

New screen grid tube—designed for same purpose as type 235, although having slightly different characteristics.

**230**

New general purpose tube, operating economically at 2 volts, giving unusual service though using very little power.

**231**

New amplifier using 2 volts and extremely low current consumption, in same group as types 230 and 232.

**232**

New screen grid tube—for use as radio frequency amplifier, operating at 2 volts.

**233**

New power amplifier in the Pentode group, operating on 2 volts with low current consumption.

**SPEED** adds new important types to an already complete line of receiving tubes.



**236**

New screen grid tube used mainly as R.F. amplifier or detector in automobile sets. In same group as type 237 and 238. Also for use in D.C. sets.

**237**

New general purpose tube—especially adapted to automobile use. Can be used either as a detector or amplifier. Also for use in D.C. sets.

**238**

New power amplifier Pentode for use in automobile receivers designed for it. Gives unusual volume for small input signal strength.

**S 84**

Developed expressly for replacement of type C 484 in Sparton sets. Somewhat similar in characteristics to the type 227.

**S 82 B**

Developed expressly for replacement of the C 182 B in Sparton sets, possessing all the peculiar characteristics necessary for this purpose.

**247**

New power amplifier Pentode, for use in the output stage of AC receivers.

**S 83**

Developed expressly for replacement of the C 183 in Sparton sets, possessing all the peculiar characteristics necessary for this purpose.

**SPEED** Quality is Making History Today. Write for Complete Details.

Still another addition to a big family. **SPEED** FOTO-LECTRIC TUBES. Standard gas-filled type, red sensitive, caesium on caesium-oxide silver-oxide. Six months guarantee against defects. Write for FOTO-LECTRIC booklet.



**CABLE RADIO TUBE CORPORATION**

230-240 NORTH 9th STREET, BROOKLYN, NEW YORK

**RCA**  
LICENSED



# Train *with* R.T.A. *for* Radio Service Work



Important and far-reaching developments in Radio create sudden demand for specially equipped and specially trained Radio Service Men.

*This excellent set analyzer and trouble shooter included with our course of training*

**M**ANY skilled Radio Service Men are needed now to service all-electric sets. By becoming a certified R. T. A. Service Man, you can make big money, full time or spare time, and fit yourself for the big-pay opportunities that Radio offers.

We will quickly give you the training you need to qualify as a Radio Service Man . . . certify you . . . furnish you with a marvelous Radio Set Analyzer. This wonder instrument, together with our training, will enable you to compete successfully with experts who have been in the radio business for years. With its help you can quickly diagnose any ailing Radio set. The training we give you will enable you to make necessary analysis and repairs.

Serving as a "radio doctor" with this Radio Set Analyzer is but one of the many easy ways by which we help you make money out of Radio. Wiring rooms for Radio, installing and servicing sets for dealers, building and installing automobile Radio sets, constructing and installing short wave receivers . . . those are a few of the other ways in which our members are cashing in on Radio.

As a member of the Radio Training Association, you receive personal instruction from skilled Radio Engineers. Upon completion of the training, they will advise you personally on any problems which arise in your work. The Association will help you make money in your spare time, increase your pay, or start you in business. The easiest, quickest, best-paying way for you to get into Radio is by joining the Radio Training Association.

This amazing Radio Set Analyzer plus the instructions given you by the Association will transform you into an expert quickly. With it, you can locate troubles in all types of sets, test circuits, measure resistance and condenser capacities, detect defective tubes. Knowing how to make repairs is easy; knowing what the trouble is requires expert knowledge and a Radio Set Analyzer. With this Radio Set Analyzer, you will be able to give expert service and make big money. Possessing this set analyzer and knowing how to use it will be but one of the benefits that will be yours as a member of the R. T. A.

## Write for No-Cost Membership Plan

We have worked out a plan whereby a membership enrollment need not cost you a cent. Our thorough training and the valuable Radio set analyzer can be yours. Write at once and find out how easily both of these can be earned.

Now is the time to prepare to be a Radio Service Man. Greater opportunities are opening up right along. For the sake of extra money in your spare time, bigger pay, a business of your own, a position with a future, get in touch with the Radio Training Association of America now.

Send for this No-Cost Membership plan and Free Radio Handbook that will open your eyes as to what Radio has in store for the ambitious man. Don't wait. Do it now.

**RADIO TRAINING ASSOCIATION OF AMERICA**  
Dept. RCA-9      4513 Ravenswood Ave.      Chicago, Ill.

Fill Out and Mail Today!

**RADIO TRAINING ASSOCIATION OF AMERICA**  
Dept. RCA-9, 4513 Ravenswood Ave., Chicago, Ill.

Gentlemen: Send me details of your No-Cost Membership Enrollment Plan and information on how to learn to make real money in radio quick.

Name .....

Address .....

City..... State.....

H. GERNSBACK, President  
 S. GERNSBACK, Treasurer  
 J. M. HERZBERG, Vice-President  
 I. S. MANHEIMER, Secretary



R. D. WASHBURNE,  
 Technical Editor

C. P. MASON,  
 Associate Editor

VOLUME III  
 NUMBER 3

## Contents of This Issue

SEPTEMBER  
 1931

	PAGE		PAGE
EDITORIAL:		An Imported Hint for the Radio Industry.....	154
Whither Radio Sets?.....By Hugo Gernsback	139	How to Test the Pentodes.....By F. L. Sprayberry	155
NEW DEVELOPMENTS IN RADIO:		RADIO CONSTRUCTION AND THEORY:	
The Radio "Sherlock Holmes".....	140	The RADIO-CRAFT A.C. Pentode Portable.....	156
The Latest Radio Devices.....	141	Up and Down the Waves with the Scott "All-Wave Superheterodyne".....By Marcellus H. Gernsback	158
SOUND RECORDING:		A Short-Wave Converter for D.C. Light-Lines By W. E. Smith	159
Control Units for Sound Recording..By George J. Saliba	142	Short-Wave Converter Operation (Part II) By Ronald Lewis	160
Experiments in Home Recording.....	180	Pentodes and Their Use (Part II)...By C. E. Denton	161
SERVICE MEN'S DEPARTMENT:		Single-Control Design for Superheterodynes By C. H. W. Nason	164
Going After Service.....By J. P. Kennedy	144	Short-Wave Inductances and How to Figure Them (Part II) .....	165
Design of Oscillators for Servicing By C. H. W. Nason, A. R. Haidell, H. Weiler	146	The Design of Power Transformers...By C. W. Palmer	166
Favorite Testing Equipment of Service Men.....	147	Seeing "Sound Waves" .....	169
The Sonora Specialist.....By George F. Brooks	148	Improving Treble Quality.....By C. H. W. Nason	169
Servicing—as Others See It.....	149	The Radio Craftsman's Own Page.....	170
Extending the Speaker.....By John J. Nothelfer	149	RADIO-CRAFT'S Information Bureau.....	172
RADIO SERVICE DATA SHEETS:		Radio Book Review.....	189
No. 49—Apex "Series 31" .....	150		
No. 50—Phileo "Model 3 Transitone".....	151		
Leaves from Service Men's Notebooks.....	152		
The Service Man's Open Forum.....	154		

### In Forthcoming Issues

**HOME TALKIES AND THE RADIO.** The increasing vogue of moving-picture projectors for the home brings to the front the problem of sound accompaniment, reproduced through the amplifier of the radio receiver. The alert Service Man will see financial possibilities in the idea.

**MULTIPLE RADIO INSTALLATIONS.** Information on the installation and servicing of the "Antenaplex" and "Centralized Radio" systems; by which an apartment building or hotel utilizes a single receiving antenna, either for independent tuning of individual sets, or distribution of selected programs from a master amplifier.

**AN UP-TO-DATE SET ANALYZER,** by Arthur G. Mohaupt. To equip its students for radio servicing, a large correspondence school (the Radio Training Association, of

Chicago) has designed a versatile testing instrument to meet their needs. Its circuit and design will be fully described.

**A SIMPLIFIED SUPERHETERODYNE,** by H. G. Cisin, whose latest ingenious design is a "super" with only three tubes, besides the rectifier for A.C. operation. Full constructional details will be given.

**THE SPEECH INVERTER.** Short-wave fans have noticed, of late, that transoceanic telephone conversations are "scrambled." The method of scrambling speech is explained, and will afford interesting possibilities for the experimenter.

**THE A.C. SUPERREGENODE.** Further improvements and added power are provided in this ultra-sensitive circuit; which is especially adapted to reception on very short waves, with a superaudible suppressor-frequency.

RADIO-CRAFT is published monthly, on the fifth of the month preceding that of date; its subscription price is \$2.50 per year. (In Canada and foreign countries, \$3.00 a year to cover additional postage.) Entered at the postoffice at Mt. Morris, Ill., as second-class matter under the act of March 3, 1879. Trademarks and copyrights by permission of Gernsback Publications, Inc., 98 Park Place, New York City.

Text and illustrations of this magazine are copyright and must not be reproduced without permission of the copyright owners. We are also agents for WONDER STORIES and WONDER STORIES QUARTERLY. Subscriptions to these magazines may be taken in combination with RADIO-CRAFT at reduced Club rates. Write for information.

Copyright 1931, GERNSBACK PUBLICATIONS, INC.

Published by  
**TECHNI-CRAFT PUBLISHING CORPORATION**

Publication Office: 404 No. Wesley Ave., Mount Morris, Illinois

Editorial and Advertising Offices  
 96-98 Park Place, New York City

Chicago Advertising Office  
 737 North Michigan Avenue, Chicago, Ill.

Western Advertising Office  
 220 No. Catalina St., Los Angeles, Calif.

L. F. McCLURE, Chicago Advertising Representative

LOYD B. CHIAPPELL, Western Advertising Representative

London Agent: Hachette & Co.,  
 3 La Belle Sauvage, Ludgate Hill, E.C. 4

Paris Agent: Hachette & Co.,  
 111 Rue Reaumur

Australian Agent: McGill's Agency,  
 179 Elizabeth St., Melbourne



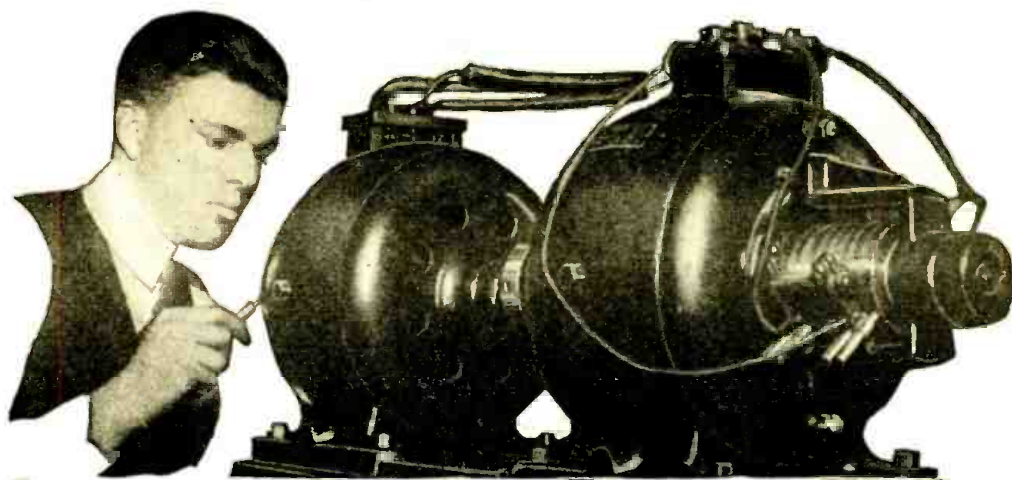

# Amazingly Easy Way to get into **ELECTRICITY**

Don't spend your life waiting for \$5 raises in a dull, hopeless job. Let me show you how to prepare for a real job and how to make real money—in **ELECTRICITY**, the money-making field. Getting into Electricity is far easier than you imagine!

## 12 Weeks of Practical Shop Training

Come to Coyne in Chicago and learn Electricity the quick and practical way—by actual shop work on actual machinery and equipment. No useless theory! The average time to complete the course in only 12 Weeks. You work on real dynamos, switchboards, armatures, auto and airplane engines, transmitting stations, etc.—everything from door bells to power plants—in full operation every day! No previous experience necessary.

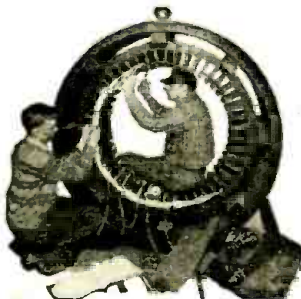

**Prepare for Jobs Like These**

Here are a few of the splendid positions open to Trained Electrical Men!

Power Plant Operator	\$40 to \$60 a week
Maintenance Engineer	\$250 to \$600 a month
Armature Winding	\$45 to \$75 a week
Auto Ignition	\$45 to \$65 a week
Contractor-Dealer	\$3,000 to \$10,000 a year
Motor Inspector	\$200 to \$300 a month
Electric Lighting	\$40 to \$70 a week
Signal Engineering	\$50 to \$75 a week

### Coyne is 32 Years Old

Thirty-two years is a long time. No school or business could continue that long unless it were rendering real service and getting real results. Yet Coyne has been located right in Chicago since 1899. Coyne Training is tested—proven by hundreds of successful graduates.

### What Graduates Say About Coyne

"One week after graduating, I started my electrical job," writes Leland Hinds of Indiana. "After graduating I was home only two days when appointed Engi-

neer in a light plant in South Dakota," writes George Bagley, of Canada. Two weeks after graduating I received a splendid job. The main consideration given my application was that I was a Coyne Trained man," reports Harold Soucy of Illinois. "I wish to thank your Employment Manager for securing this position for me," writes Albert Yagon, "he sent me out to this Company the first day and I was employed there immediately." And I could go on quoting from hundreds of letters of successful Coyne Trained Men. What they have done, you should be able to do!

## Get the Facts

Get all the facts! You can find out everything absolutely free. **JUST MAIL THE COUPON BELOW FOR A FREE COPY OF OUR BIG ELECTRICAL BOOK**, telling all about jobs . . . salaries . . . opportunities. This does not obligate you. Just Mail the Coupon!



## FREE Employment Help

When you graduate, we'll do all we can to help you get the job you want. We employ three men on a full time basis whose sole job is to help secure positions for our students. Also we'll help you to earn while learning. Some of our students pay a large part of their living expenses through part-time work we get them.

### Now in Our New Home

This is our new fire-proof, modern home wherein is installed thousands of dollars' worth of Electrical Equipment of all kinds. Every comfort and convenience has been arranged to make you happy and contented during your training.



**COYNE ELECTRICAL SCHOOL**  
 H. C. LEWIS, Pres. Founded 1899  
 500 S. Paulina St., Dept. 61-82, Chicago, Ill.

H. C. LEWIS, President  
**Coyne Electrical School**  
 500 S. Paulina St., Dept. 61-82, Chicago, Ill.

Dear Mr. Lewis:  
 Without obligation send me your big free catalog and all details of your Free Employment Service, and how I can "earn while learning."

Name.....  
 Address.....  
 City.....State.....

**A Better TUBE<sup>\*</sup>  
KEEPS  
A Customer  
LONGER  
Satisfied**



**W**HEN you speak about the replacement —you should talk PERRYMAN.\* You as counsel to your customers must be backed by a tube of outstanding quality. PERRYMAN tubes meet the most exacting requirements and will build permanent good will and an ever increasing volume of sales for you.



Your stock should include a varied supply of PERRYMAN Tubes. Write Dept. RC for the name of nearest wholesale distributor; also our special proposition for service men.

PERRYMAN Tube production has increased steadily during the past few months to keep pace with the demand for new tubes. The new low list prices have been carefully adjusted to enable dealers and servicemen to make a fair profit—PERRYMAN Replacement Policy assures recommendation by others for new tubes.

**PERRYMAN ELECTRIC CO.**  
INCORPORATED

**NORTH BERGEN :: :: NEW JERSEY**

**PERRYMAN**



**RADIO TUBES**



# BIG PAY JOBS

*open*

## for the Radio Trained Man

Scores of jobs are open to the Trained Man—jobs as Designer, Inspector and Tester—as Radio Salesman and in Service and Installation work—as Operator, Mechanic or Manager of a Broadcasting station—as Wireless Operator on a Ship or Airplane—jobs with Talking Picture Theatres and Manufacturers of Sound Equipment—with Television Laboratories and Studios—fascinating jobs, offering unlimited opportunities to the Trained Man.

## Ten Weeks of Shop Training

Come to Coyne in Chicago and prepare for these jobs the QUICK and PRACTICAL way — BY ACTUAL SHOP WORK ON ACTUAL RADIO EQUIPMENT. Some students finish the entire course in 8 weeks. The average time is only 10 weeks. But you can stay as long as you please, at no extra cost to you. No previous experience necessary.

## TELEVISION *and* TALKING PICTURES

In addition to the most modern Radio equipment, we have installed in our shops a complete model Broadcasting Station, with sound-proof Studio and modern Transmitter with 1,000 watt tubes—the Jenkins Television Transmitter with dozens of home-type Tele-

vision receiving sets—and a complete Talking Picture installation for both “sound on film” and “sound on disk.” We have spared no expense in our effort to make your training as COMPLETE and PRACTICAL as possible.

## FREE Employment Service to Students

After you have finished the course, we will do all we can to help you find the job you want. We employ three men on a full time basis whose sole job is to help our students in finding positions. And should you be a little short of funds, we'll gladly help you in finding part-time work while at school. Some of our students pay a large part of their living expenses in this way. Mail the coupon below!



### COYNE IS 32 YEARS OLD

Coyne has been located right here in Chicago since 1899. Coyne Training is tested—proven by hundreds of successful graduates. You can get all the facts—FREE. JUST MAIL THE COUPON FOR A FREE COPY OF OUR BIG RADIO AND TELEVISION BOOK, telling all about jobs . . . salaries . . . opportunities. This does not obligate you. JUST MAIL THE COUPON!

**RADIO COYNE ELECTRICAL SCHOOL**  
DIVISION **COYNE** H. C. LEWIS, President Founded 1899  
500 S. Paulina St., Dept. 61-9K, Chicago, Ill.

H. C. LEWIS, President

Radio Division, Coyne Electrical School  
500 S. Paulina St., Dept. 61-9K, Chicago, Ill.

Send me your Big Free Radio and Television Book. This does not obligate me in any way.

Name .....

Address .....

City..... State.....

# Pilot Achieves Radio's Greatest Sensation!

## The Entire World of Radio



# PILOT UNIVERSAL SUPER WASP RECEIVER

Partly assembled "Universal" for the man who likes to "roll his own". With walnut cabinet, less tubes and speaker.

**85<sup>00</sup>**

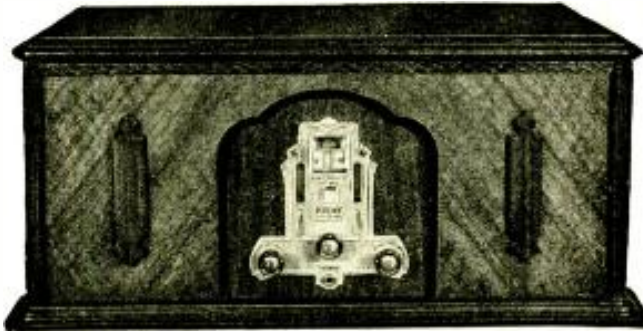

Pilot's wonderful wave band changing switch, incorporated in the new Universal Super-Wasp, revolutionizes the short wave art. No longer need numerous coils be changed to cover the various wave bands. No longer need dial settings change each time the same distant stations are tuned in. You can log permanently all the stations you can get throughout the world, you can tune from the short waves to the high ship waves without removing your hand from the single control knob.

### Universal Features Revolutionizing the Short Wave Art

Complete coverage all wave bands from 15 to 650 meters *without coil changing*. Complete A.C. operated *chassis in cabinet*. (Also available in battery model) . . . All *Metal Chassis*

. . . Highly sensitive and selective circuit . . . Screen Grid TRF amplifier *plus* Screen Grid *Detector* . . . 227 First Audio Stage . . . Two 245's in push-pull output stage . . . Stations can be logged *permanently on dial* . . . Regeneration control does not alter tuning . . . Provision for *Phonograph Pick-up* . . . Earphone Jack on *Front Panel* . . . Illuminated Dials . . . Handsome Walnut Cabinet . . . Most advanced construction yet used for short wave work . . . In kit form for easy home assembly; no drilling or cutting, all parts fully prepared.

NOTICE TO "HAMS": Pilot will continue building the original Super-Wasp in kit form for licensed amateurs and others who want to spread the tuning on their pet wave bands and add their own audio features. A.C. and battery models.

## PILOT RADIO & TUBE CORP., Lawrence, Mass.



Chicago: 234 S. Wells St.

New York: 525 Broadway

San Francisco: 1278 Mission Street

OFFICES IN PRINCIPAL COUNTRIES OF THE WORLD



# Get Into One Of These BIG PAY FIELDS



Practical work on real  
Electrical machinery



Student working on Television  
transmitter in  
Coyne Radio Shops

## Amazingly Easy Way to Get Into ELECTRICITY

Dissatisfied with your job? Not making enough money? Then let me show you an amazingly easy way to get into **ELECTRICITY**, where thousands of Trained Men are drawing down Big Pay envelopes every week. Coyne has been training men for the Electrical Industry since 1899. Let Coyne help you to a place in this great money-making field.

## Learn **RADIO** **TELEVISION** TALKING PICTURES

Prepare for jobs in Service Work, Broadcasting, Talking Pictures, Wireless Operating, etc. Get in on the ground-floor of Television! Radio has grown in a few years from a mere experiment to a **BILLION DOLLAR** industry. Scores of jobs are open to the Trained Man. Prepare for them now by actual work in the great Coyne Radio Shops!

## Practical Work in the Great Coyne Shops

Come to Coyne in Chicago and learn one of these two great Trades the **QUICK** and **PRACTICAL** way — **BY ACTUAL WORK ON ACTUAL EQUIPMENT**. In the Electrical School you are trained on huge motors, generators, switchboards, auto and airplane engines, etc. No useless theory! The

average time to complete the Course is only 12 weeks. In the Radio School the average time is 10 weeks. Here we have complete Radio, Broadcasting, Television and Sound Reproduction equipment. Everything that is necessary to make your training as complete, practical and resultful as possible!

## Free Employment Service to Students

When you Complete the Course, we'll do all we can to help you find the job you want. We employ three men on a full-time basis whose sole job is to help secure positions for our students. And if you are a little short of funds, we'll gladly help you in finding part-time work while at school. Some of our students pay a large part of their living expenses that way.

But get all the facts! Select the field you like the best and mail one of the two coupons below. Let me send you either my **BIG FREE ELECTRICAL BOOK** or my **BIG FREE RADIO AND TELEVISION BOOK**. Mail only one coupon, but be sure to mail it at once! This will not obligate you in any way! So mail the coupon **NOW!**

### MAIL ONLY THIS COUPON FOR FREE ELECTRICAL BOOK

H. C. LEWIS, President  
**Coyne Electrical School, Dept. 61-81,  
500 South Paulina Street, Chicago, Illinois**  
Gentlemen: Please send me your big Free Electrical Book with 151 illustrations. This does not obligate me in any way.

Name.....  
Address.....  
City..... State.....

### MAIL ONLY THIS COUPON FOR FREE RADIO BOOK

H. C. LEWIS, President  
**Radio Division, Coyne Electrical School  
500 S. Paulina St., Dept. 61-81 Chicago, Ill.**  
Gentlemen: Send me your Big Free Radio, Television and Talking Picture Book. This does not obligate me in any way.

Name.....  
Address.....  
City..... State.....



# BIG News for you

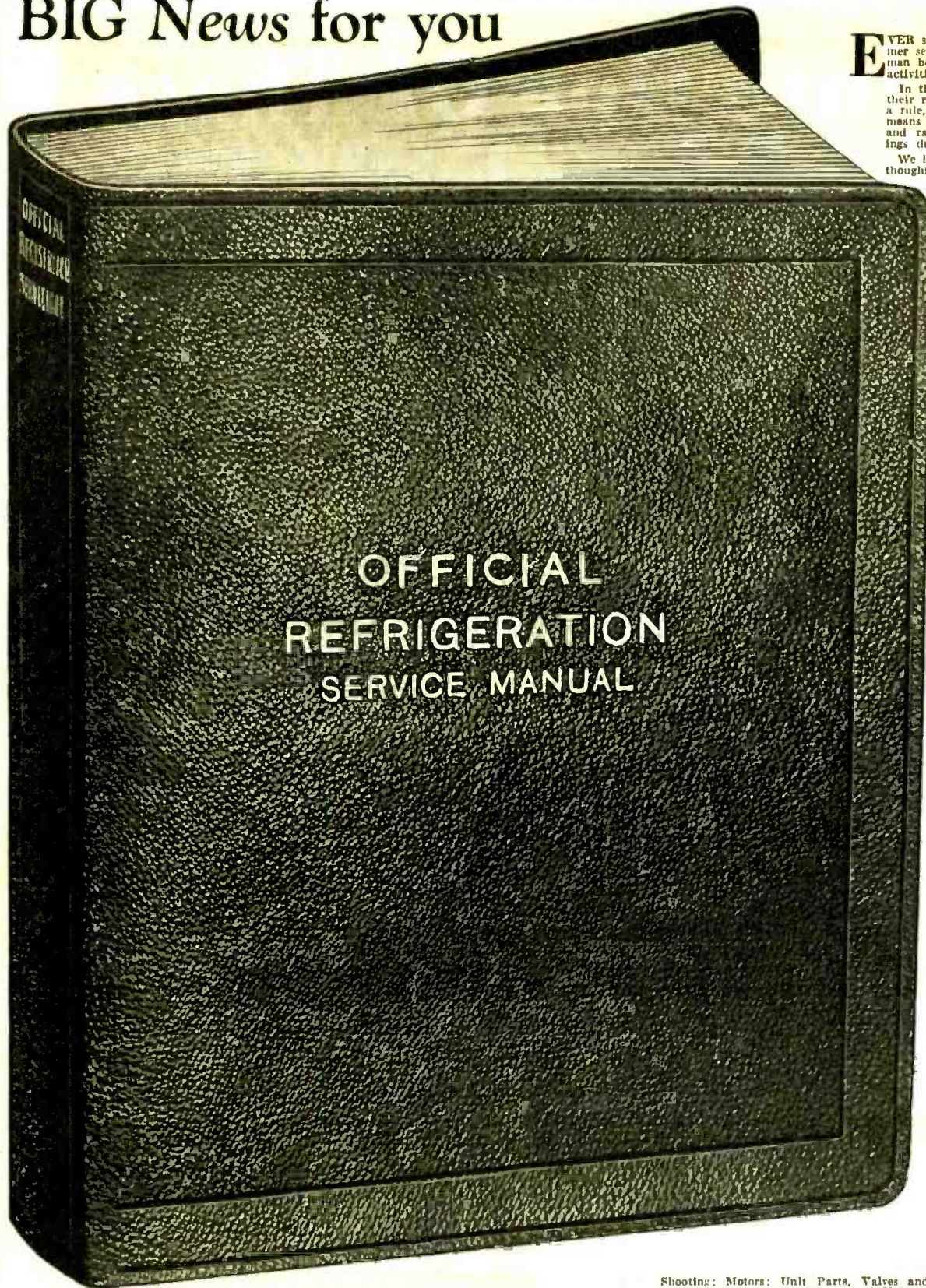

## OFFICIAL REFRIGERATION SERVICE MANUAL

**E**VER since the advent of radio, the summer season has been a curse to the radio man because that is the time when radio activities are at their lowest.

In the summer time, people do not use their radio sets so much and there is, as a rule, little servicing to be done. This means that the average radio service man and radiotician finds pretty slim pickings during the summer months.

We have given this problem considerable thought and for over a year worked quietly on the problem; and from now on every radio man, service man and radiotician will have a steady income all the year around, incredible as this may seem.

The idea of radio people servicing refrigeration units is self-evident and the thought has occurred to perhaps untold thousands of radio men ever since electric refrigeration started. Yet nothing was done, because the average radio man knows little or nothing about refrigeration. Our survey of the field convinces us that, compared with servicing a radio set, the servicing of a refrigerator is absurdly simple, once you get the hang of it; and that is exactly why the **OFFICIAL REFRIGERATION SERVICE MANUAL** is going to be a side-partner to the **OFFICIAL RADIO SERVICE MANUAL**, with which you are well acquainted.

When you are called in to service a radio set, it is easy to find out if your customers own a refrigerator. If they do, you can now tell them that you can service the refrigerator as well. Place your card somewhere near the refrigerator so that, if trouble comes, you will be called in to fix it.

From whatever point you look at it, you will make money. And don't ever lose sight of the fact that refrigerators usually need servicing in the summer time and that it is here that you will get a new and extra income.

But don't take our word for all this. Study the situation yourself and see if we are not right. Look around in your locality and find out how many refrigerators there are. At the present time the servicing of these refrigerators goes to other trades when this business might just as well belong to you.

So we say to you, why not go into the refrigeration servicing business at once? Remember, there is big money in it and the refrigeration business is growing enormously every year; and it won't be very long before there will be more refrigerators than radios.

The **OFFICIAL REFRIGERATION SERVICE MANUAL** has been edited by I. K. Wright, who is an expert and a leading refrigeration authority. He is a member of the American Society of Mechanical Engineers, American Society of Refrigeration Engineers, The National Association of Practical Refrigeration Engineers, etc.

The new Manual, as you will see from the photographic reproduction, is the same size as our **OFFICIAL RADIO SERVICE MANUAL**. It will be 9 x 12 inches, and will contain 352 pages—loose-leaf, bound in leatherette, gold-stamped cover; in fact, it is a gold mine of information on the entire art of refrigeration.

Here are the chapter contents: Preface; Introduction; History of Refrigeration; Fundamentals of Refrigeration; Description of All Known Types of Refrigeration; Service Tools and Shop Equipment; Trouble

Shooting; Motors; Unit Parts, Valves and Automatic Equipment; Manufacturers, Makes and Specifications of Units; Manufacturers of Cabinets.

Every page is profusely illustrated; every refrigerator part is explained; diagrams are furnished of every known machine; special care is given to the servicing end, of course; all the tools needed are illustrated and their use explained; there are trouble shooting charts, and other service data.

This by no means exhausts the contents of the book, and it would take much more space to give you all of the details. Last year, when we brought out the **OFFICIAL RADIO SERVICE MANUAL**, we made a special pre-publication offer to our friends, which actually saved them thousands of dollars. We are now giving you the same chance again for a very short time.

### SPECIAL PRE-PUBLICATION OFFER

The regular price of the **OFFICIAL REFRIGERATION SERVICE MANUAL** is \$5.00 after it is published. To you, the book will be sold at \$3.50 prepaid if you send in your order at once before the publication of the book. Please use the coupon. The whole book is now ready for the printers and we are putting on the last finishing touches. It will be in the printer's hands in a few weeks. Once the **OFFICIAL REFRIGERATION SERVICE MANUAL** is issued, you know from experience that we cannot allow any price reduction and, the instant the book comes off the press, the price will be \$5.00.

**GERNSBACK PUBLICATIONS, Inc.**

96-98 Park Place

New York, N. Y.

GERNSBACK PUBLICATIONS, Inc.  
96-98 Park Place, New York, N. Y.

30-8

As per your special pre-publication offer, I enclose herewith my remittance for \$3.50 (check or money order preferred) for which you are to send to me, postage prepaid, one copy of the **OFFICIAL REFRIGERATION SERVICE MANUAL** as soon as it comes off the press. I understand that the price upon publication will be \$5.00 per copy and this special offer will be void.

Name .....

Address .....

City .....

State .....





# My NEW Book is ready for You

**IF you're in Radio now**  
*spare time or full time -*  
**it will show you how**  
*my improved training*  
**can help you make**  
*still more money*



**If you're not in Radio /**  
**this book will show you how**  
**you can get in quickly !**

**R**ADIO'S continued amazing growth and new uses of Radio principles is opening hundreds of fine jobs every year. Broadcasting Stations, Radio Dealers, Jobbers and Manufacturers, Shipping Companies, Aviation, Talking Movies, Research Laboratories and many other sources of good jobs need men well trained in Radio continually. Besides, there are almost unlimited opportunities for a profitable spare-time or full-time Radio business of your own. Many of my graduates have jumped from \$25, \$35 and \$40 a week to \$50, \$60, \$75 and even \$100 a week within a year or less. My book proves this.

**I Will Train You Inexpensively At Home In Your Spare Time**

Hold your job until you are ready for another. Give me part of your spare time. I will give you the training that is raising hundreds of men's salaries every year. I send you eight big outfits of real Radio parts and show you how to do over 100 experiments with them that make clear the basic principles of whatever branch of Radio you enter—and show you how to service practically every type of set made.

**Many Make \$10 to \$30 a Week In Spare Time While Learning**

The day you enroll I will show you how to do 28 jobs common in most every neighborhood. Nearly every one of the thirteen million Radio sets in use needs \$2 to \$10 servicing a year. Get some of this money for yourself. I will show you how to do it. I will give you the plans and ideas that are making \$200 to \$1,000 for many of my students while they are taking my course. Read their letters in my book.

**Find Out What Radio Offers You Get My New Free Book**

It tells you where the good Radio jobs are, what they pay, how you can fit yourself right at home in your spare time to get into Radio. It tells you about my iron-clad Money-Back Agreement and the many extra services and materials that the National Radio Institute gives its students and graduates: Lifetime Employment Service and other features. It shows you what others who have taken my course have done—are making—what they think of it. There is no obligation. Send the coupon today.

J. E. SMITH  
 President, National Radio Institute, the man who has directed the Home-Study Training of more men for the Radio Industry than any other man in America.

**I Help You Specialize Through My Five New Advanced Courses**

My training not only gives you a thorough knowledge of Radio—all you need to get and hold a good job—but, in addition, you may take any one of my new advanced courses, without extra charge. They are:

1. TELEVISION Theory and Practice
2. AIRCRAFT RADIO
3. BROADCASTING Commercial and Ship Radio Stations
4. SOUND PICTURES AND PUBLIC ADDRESS SYSTEMS
5. ADVANCED RADIO SERVICING AND MERCHANDISING

"Rich Rewards in Radio" gives you an outline of these courses. Get a copy. See how valuable this new idea in Home Study Training can be to you.

**7 Years Previous Experience**



"Dear Mr. Smith: Before taking your course, I had worked at Radio for over 7 years. But I realized I needed better training to succeed in the Radio business. Every part of the course has been very clear, teaching me what I could not have learned otherwise. In the 9 months since November, I have made \$3,500." - C. J. Steiner, 23 S. Sandusky St., Delaware, Ohio.

**Former Service Man Increased Salary**

"Dear Mr. Smith: I had been doing service work before taking your course. Now I am serving in the capacity of Field Engineer for the Central Public Address Systems, a position I feel I can serve well, due to your thorough training. Compensation is expected to run about \$3,500 per year." - Paul E. Reiss, 2015 Kerent Place, E. St. Louis, Ill.



**H**AVE YOU read my new book giving an outline of National Radio Institute's improved training in Radio? If you haven't, send for your copy today—it's free. No matter what kind of a job you may have in the Radio industry now, unless you are at or near the top, I believe my training can help you get ahead—make still more money—get a still better job. However, I'll let you decide that for yourself after you have read my book—just let me show you what I have to offer. Many others in Radio—amateurs, spare-time and full-time service men, Radio dealers, fans, custom set builders—have found the way to more profit and more money through this course. You will find letters from them in my book.

**See What I Offer Those Who Are Now or Who Want To Be Service Men**

While my course trains you for all branches of Radio—I am also giving extensive, thorough and practical information on servicing almost every type of receiving set made. The 100 experiments I show you how to make with the eight big Home Experimental Outfits I send you make learning at home easy, interesting, practical. This information is of special help—real money-making value—to those who are now service men or those who want to be service men. This part of my training, however, is only one of 18 features that I am offering men and young men who want to get good jobs in the Radio industry—or who are in Radio and want to advance. Even though you may have received information on my course before, unless you have gotten my newly revised book as pictured above, write to me again—see how N. R. I. has grown and improved, too. Hundreds of men in Radio owe their success and larger income to it. Send the coupon today.

**CLIP AND MAIL THIS Coupon DO IT TODAY**

J. E. SMITH, President  
 National Radio Institute, Dept. 1JX  
 Washington, D. C.

Dear Mr. Smith: Send me your free book, "Rich Rewards in Radio." I want the facts on the opportunities in Radio and your revised and improved course. I understand this does not obligate me and that no agent will call.

Name.....  
 Address.....  
 City..... State.....



# All You Need to Know

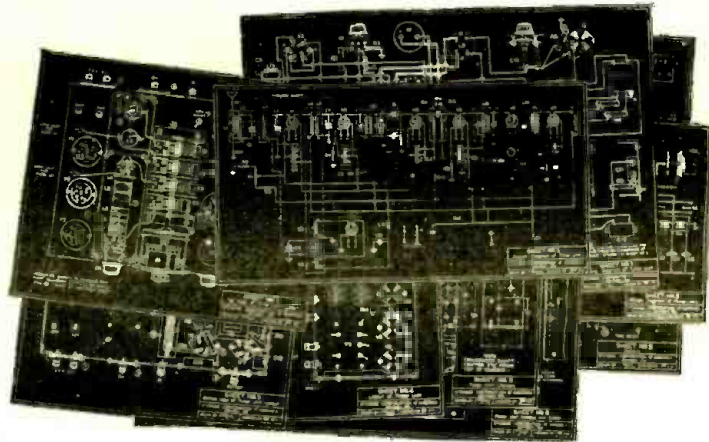

to Build the World's Best Receiver

# STENODE

Designed by Stenode Engineers under  
the direction of Dr. James Robinson

The absolutely revolutionary receiver which makes possible for the first time Superheterodyne reception so quiet you can hear no noise between stations . . . all musical tones as no other method can reproduce them.

Dr. James Robinson, former Chief of Wireless Research, British Royal Air Force, has given you an entirely new principle of radio reception in the STENODE, not merely a rehash of worn out principles. Build a STENODE! Be a radio leader in your community. Learn for yourself and prove to your friends what it means to have

## 500% Better Selectivity

STENODE tuning is so sharp that it requires a 300 to 1 ratio dial. Turned up to full sensitivity there is no noise in tuning the STENODE until a station is reached. Stations come in "crystal clear"—an absolute replica of the studio performance, whether 5 or 500 miles away. There is nothing else like it in all radio. STENODE owners are the envy of their friends—no matter what other circuits they use. A STENODE log is not merely a log of stations painfully identified, but of stations listened to with pleasure. Because—on locals or DX—the STENODE gives—

## 1000% More Freedom from Noise

By the STENODE principle the highest selectivity ever attained does not cut down tonal range or audio quality, which all engineers agree must be the case with other receivers. You can tune out heterodyne whistles on a STENODE while keeping your station clear and full in volume. STENODE gives—

## Infinitely Better Quality

The STENODE opens up new fields for short-wave and television work, as well as broadcasting. Full details of all sorts of applications are given in the STENODE Data Book. Nine full-sized diagrams show where to place every part. How to make every connection is clearly told in STENODE Book of Directions. Your finished STENODE will put you into a new field of radio. Fill in and mail the coupon with your money order for the biggest value ever offered custom set builders.

**STENODE CORP. OF AMERICA**  
HEMPSTEAD GARDENS, L. I., N. Y.  
(FORMERLY AMERICAN RADIOSTAT CORP.)



**9 Blue Prints  
Data Book  
Direction Book**  
All for **\$10**  
ONLY

STENODE selectivity curve makes 10KC selectivity, so-called, look like broad tuning.

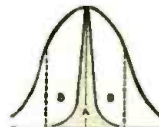

STENODE selectivity is compared, at left, to that of ordinary receivers. All background noise is contained in outer curve. Stenode's curve, shaded, contains but 1-10 the total noise.



STENOTUBE. Only one required in each Stenode. This heart of the Stenode circuit consists of a quartz crystal ground to 175KC frequency and mounted in tube form for easy handling. Standard UX socket base. Price \$15.

Made in England None genuine without the inventor's signature—

*James Robinson*

**STENODE CORP. OF AMERICA**  
Hempstead Gardens, L. I., N. Y.

Enclosed find  Money Order,  Check, for \$..... Please forward me  STENOTUBE,  BLUE PRINTS, DATA BOOK and DIRECTION BOOK for building STENODE.

Name .....

Street .....

City ..... State .....

**IF IT ISN'T A STENODE IT ISN'T A MODERN RECEIVER**





“Takes the Resistance Out of Radio”

Editorial Offices, 96-98 Park Place, New York, N. Y.

# Whither Radio Sets?

By HUGO GERNSBACK

**O**F late, it has become apparent that radio history in many instances is manifesting a tendency to repeat itself in spots. This tendency seems to grow more acute as time rolls on.

You will remember that in 1923 the universal radio set contained a single tube which was, at that time, a marvel in performance; at least, as far as distance and quality were concerned, even though we did have to use headphones.

The next step was the amplifier added to the one-tube set, which gave us a three tube set, which was for a time in great vogue. It took several years for the tuned-radio-frequency, five-tube set to come into general use; and then, for a time, this was the standard.

Still the radio cycle continued upwards, and the multi-tube sets continued to take on more tubes as the years went by; until we arrived at the average of about eight tubes, which was reached about two years ago.

Since that time, the radio pendulum has swung the other way, and we are now receding from the peak of the curve. With the great popularity of the midget sets, which are now swamping the country, we have arrived once more at the standard five-tube set, and the pendulum still continues swinging the other way. Already, four-tube sets have made their appearance, and seem to be quite popular.

What is the end? Will we go back to the single-tube set? Possibly not, unless the single-tube set of the future is to have a number of tube elements incorporated in the one envelope; but this again, will not be a novelty, because such tubes have already been produced.

We are inclined to think, rather, that the average radio receiver during the next few years—and that, of course, includes the midget—will perhaps be a three-tube set. These three tubes will, really, include only two receiving tubes; because one of them will be the rectifier. The other two will be respectively, in all probability, a superior screen-grid tube and a superior pentode. This statement sounds fantastic at this time, but in reality it is not.

In the present issue there is described a portable three-tube set of this variety, built by RADIO-CRAFT'S Laboratories. While it was primarily designed as a portable set, yet the basic features of this set could easily be commercialized, and no doubt will be soon. A different circuit, of course, will be used; because that developed for this portable, under limitations of space, is naturally not the best which could be evolved.

And let no one think that such a receiver produces only head-phone volume. Quite to the contrary! This set uses a good dynamic speaker, and for volume outperforms many a five- and six-tube set. Indeed, it was impossible to turn on the set to full volume; because the sound was so tremendous in a medium-sized room that it was uncomfortable.

If this sort of thing can be done today, with the tubes which we have now at our command, what then will be the result a year or two hence, when the tubes have been made a great deal better than they are now, and when suitable circuits have been perfected?

We will probably be criticised for suggesting the return of a three-tube set, just as the manufacturer of the first five-tube midget set was criticised; but (unfortunately for the critics) in radio, it is impossible to hold back progress. And let no one jump at the conclusion that a three-tube set must necessarily be a \$10.00 affair, made to sell in quantities. Quite to the contrary, such a three-tube set can be marketed for \$150.00; because it all depends on the components that goes with the tubes. Certain refinements can, and will, of course, be added. To mention only one, a Stenode Radiostat might be included, which certainly would make the three-tube set equal to, and outperform any present six- and even ten-tube, set.

Radio engineers and radio designers know full well that a ten-tube set is not of necessity more sensitive nor more powerful than a four- or five-tube set, providing the latter makes use of all the inherent amplification that can be secured from the tubes.

Very often in the past, multi-tube sets of the ten-tube variety have hidden many defects, and the extra tubes, in many instances, served no useful purposes.

Then again, today, people who buy sets are not looking so much for distance as they did in former years. In the future, the man who buys the three-tube set will do so to get stations within a radius of 150 to 200 miles. If he wishes to get a set for long distance or for DX, there will be for him a set of the five- or six-tube variety, should he desire such a receiver.

One thing, however, is certain; and it is that, in 1932 and 1933, three-tube sets will be just as sensitive and just as powerful as the present five- and six-tube sets.

What the radio industry will do about it, no one, of course, can now foretell. During the past few years, the radio set industry chose, in a large degree, to commit suicide by selling sets at such ridiculous prices that, so far as the manufacturers were concerned, they really were giving the sets away; and many set manufacturers have gone out of business, as a result of yielding to this tendency.

Contrary to belief, it is possible that the radio industry, even with the three-tube set, can make money if it chooses to lay down a real merchandising policy, instead of blindly following the next price-cutter who may not be in business six weeks hence.

The radio industry should not fail to keep before it the most important fact that the *radio set market is not yet saturated*: there are some twenty-six million homes in this country of which not more than half have radio sets. (In the first forty states tabulated in the United States Census of 1930, which include few of the larger ones, there were only 3,005,327 radio sets in 9,707,071 homes, a percentage of only 32.6; and the average for the remaining 18 states will probably bring this to not over 50%). In other words, half the homes in the United States are excellent prospects for radio. From this it will be seen that there is still room for an enormous number of radio sets, which someone is going to supply during the next few years.

# The Radio "Sherlock Holmes"

*An electrical device which  
"sees through" all kinds  
of things*

**T**HE late Mr. Sherlock Holmes had an uncanny faculty of observation, according to his confidant and biographer, Dr. Watson; and he was readily able, with the aid of but a pocket magnifying glass, to discover many things which ordinary mortals were quite unable to appreciate.

However, Mr. Holmes seems to have been quite lacking in the power to impress his conclusions upon others, until the logic of events had introduced supplemental evidence. Though the great criminologist was readily able to frame an accurate description of an unknown individual from a footprint, a flake of ash, a scrap of paper—Messrs. Gregson and Lestrade of Scotland Yard were quite unconvinced until the offender in question had frankly confessed, with the understanding that his words would be used against him.

In other words, the personal element in observation, depending not merely upon the keenest eyesight, but on the coordination of an immense store of knowledge, is quite uncommunicable.

But, with the device illustrated here, which its inventor has called a "radio Sherlock Holmes," the conclusions can be read alike by all on the scale of a most unemotional meter, after they have been pronounced by an impartial and discriminating



**Fig. A**

*Now that the public has become accustomed to buying radio tubes from testers with dials like the old counter scales, will the ladies be equally insistent that "Sherlock Holmes" shall first pass upon the quality of their new Neverrons?*

photoelectric cell. It is true, of course, that they may call for an interpreter quite as ingenious as the wizard of Baker Street.

### True or False?

The commercial name of the apparatus illustrated is the "transmeter": it measures the translucency of any object through

obtaining greater efficiency and uniformity in manufacture. The inventor, C. C. Hein, a Westinghouse engineer, had laid before him the problem of testing the opaqueness of paper. (To measure its thickness is easier, and has been done by an ingenious method involving capacity effects.) If the paper is too translucent, the printing on one side shows through the sheet, and makes it harder to read the other side. If the paper is too thick, too much material is used. To shun the extremes of spoilage and waste is a problem in modern mass production.

After all was said and done, the demand for opaqueness was one created by the human eye; the eye afforded the most satisfactory test of quality—but the human eye tires quickly. The same sheet of paper seemed different before and after dinner; between the hours of morning freshness and the hours of afternoon weariness. Finally, the engineer determined to substitute the "electric eye"—the photoelectric cell—for the human organ of vision. The final result of his work is shown here.

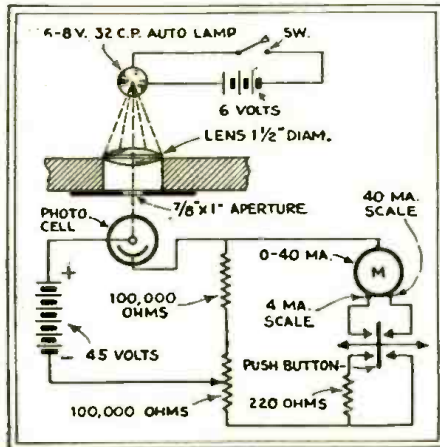

**Fig. 1**

*The electrical circuit of the photoelectric transmitter, with two scales for different translucencies.*

which light from a standard source is passing, and thereby affords a most delicate standard of comparison. We have, for instance, a document of great value—if genuine—but doubtful authenticity, such as the stock certificate illustrated in the cover picture. It is placed in the transmitter; the reading is taken, and compared with a genuine certificate of the same issue. If the readings are similar, it is indicated that they are printed on the same paper; but, if the imitation was produced at a different time and place, even the slight difference between sheets of the same make, but a different "mill run," will be apparent.

It is even believed that works of art may be tested in the manner shown to determine their similarity to other products of the age in which it is alleged that they were produced.

However, the fundamental idea which governed the inception of the transmitter was not the prevention of fraud, or the detection of crime, but the more everyday purpose of

### Arrangement of the Meter

The radio Sherlock Holmes—or transmitter—is about the size of an automobile battery. When a sheet of paper, or other thin material whose translucency is to be determined, is inserted into the slot near the bottom, it passes between a standard low-voltage electric lamp and the photocell. The light received through it, by the cell, is measured by the microammeter, set in the top of the instrument. With suitable dry-cell batteries, the device is readily portable. Its electric circuit is shown in Fig. 1, and the mechanical arrangement in Fig. 2.

For objects of different colors, certain problems arise: for the photo-cell is affected in different degree by the same amount of light energy at the different wavelengths which determine color. A piece of blue paper gives a reading of different value from a sheet of red paper of similar weight and thickness. However, even this irregularity might be regularized by preparing a suitable color-calibration chart.

One of the accompanying illustrations shows a pair of silk stockings being tested for their "sheerness" by a method more accurate than the old finger-and-thumb method.

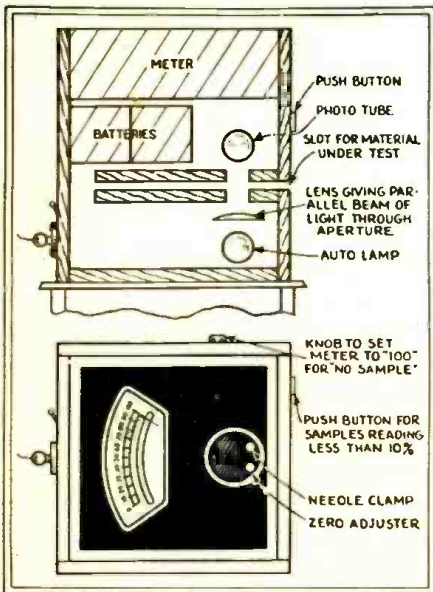

**Fig. 2**

*Construction of the transmitter for portability. (Illustrations courtesy Westinghouse El. & Mfg. Co.)*



# The Latest Radio Appliances

*New Commercial Products of interest to the radio trade, Service Men, and radio constructors.*

## TWIN-DETECTOR MIDGET SUPERHET

A VARIATION in radio set design is shown by the mantel-type superheterodyne receiver illustrated in Fig. A; the diagram of connections (Fig. 1) illustrates several novel variations from orthodox design.

The input circuit includes a band selector of the inductive-coupling type. Although



Fig. A  
The Radiette "Model 90" midget super.

the use of type '24 tubes is shown, the volume-control potentiometer, R1, is in the cathode circuit and, consequently, the circuit is readily adaptable to the use of type '35 variable- $\mu$  tubes; with corresponding reduction in the amount of cross-modulation. A "local-distance" switch, in the chassis, is the only other means of control. The tone control is of capacity-resistance type; C1-R2, connected from grid to grid of the push-pull '45's. The field coil of the dynamic reproducer obtains its current by being connected in the negative lead of the power pack. A jack is provided, for connection of a phonograph pickup in the cathode circuit of the twin-detectors.

This novel arrangement of a power detector circuit is the outstanding point of interest about the "Model 90." This twin-detector design, it will be noticed, is obtained by paralleling two type '27 tubes.

For the guidance of Service Men, the following data are furnished concerning the tube (average) operating characteristics: Plate potentials: V1, V2, V4, V5, V6, V7, V8, 225 volts; V3, 85 volts. Cathode potentials: V1, V4, 2 volts; V2, 7 volts; V3, 5 volts; V5, V6, 25 volts; V7, V8, 28 volts. Screen-grid potentials: V1, V2, V4, 85 volts. Voltages corresponding to the colored lead of the reproducer are as follows: red, 230 volts; blue, 160; black, 0.0; brown, 225. All potentials are thus indicated only on a high-resistance meter.

There are two 8 mf. sections of an electrolytic condenser, C2, in this chassis. This, the "Radiette Model 90" receiver, is a product of Keller-Fuller Mfg. Co., Ltd., Los Angeles, Calif.

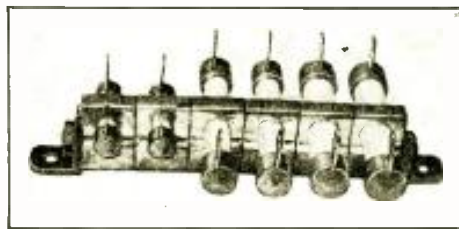

Fig. B  
Assembly of metallized resistors, producing simplicity in receiver connections.

**MOLDED GANG RESISTORS**  
A NOVEL type of resistance strip, recently put on the market, consists (as shown in Fig. B) of a number of metallized resistors of the ceramic-and-cast-metal type, with soldering leads; with an additional casting around the center of each resistance unit; and a special cast-metal center support, upon which they may be mounted to form a resistor gang. A rod is slipped through each center casting, to hold them all together.

This new type of resistor assembly is available in units of 0.5-, 1- and 2-watt ratings.

The chief advantage is low cost and convenience in assembly; since the casting is made part of the regular resistor unit, and the entire lot may be placed together wherever convenient.

These molded gang resistors are manufactured by the International Resistance Co., Philadelphia.

## INTERMEDIATE SHIELDED TRANSFORMERS

FIG. C illustrates a design of shielded I. F. transformer, equipped with primary and secondary resonating variable condensers, which has recently been put on the market as a unit to supplement other superheterodyne equipment designed by the same manufacturer.

These intermediate-frequency transformers, designed for operation at any point between 165 and 185 kc., are available in three types. The shielded "Type F" is very (Continued on page 174)

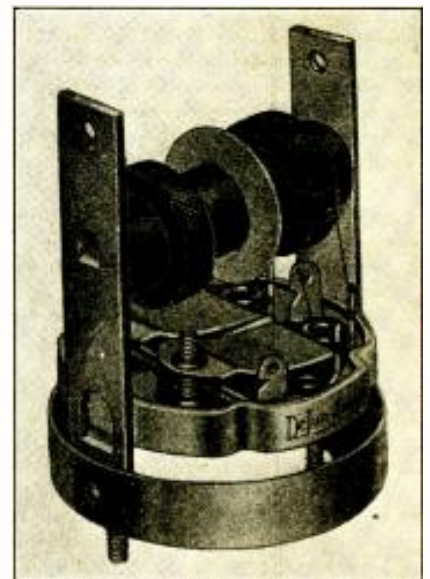

Fig. C  
The construction of the "Transitor" I.F. transformer, available in three designs.

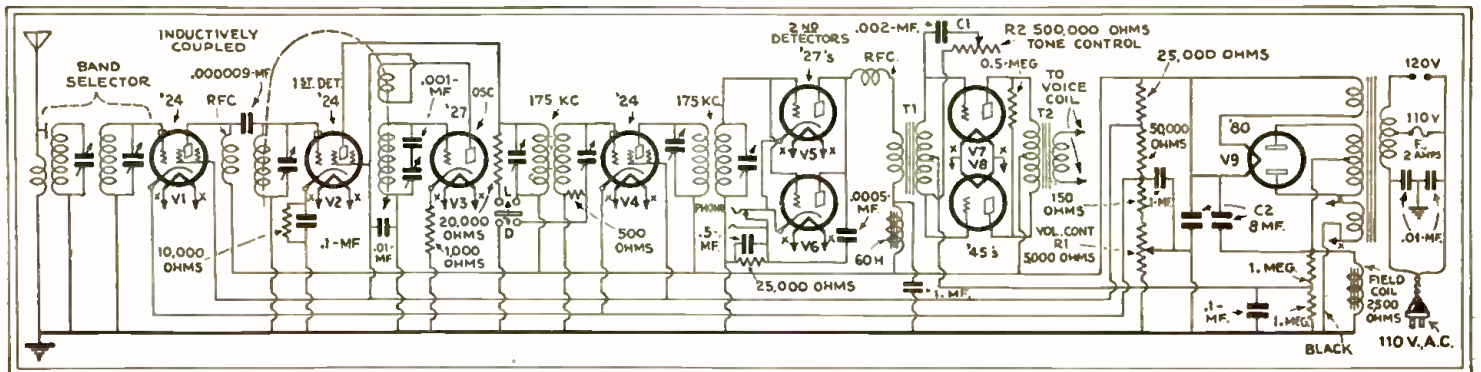

Fig. 1

Identical filament, grid and plate current and potential readings on two tubes in the detector position might come as a surprise to many Service Men; but the schematic circuit of the Radiette "Model 90" receiver, above, incorporates such a twin-detector connection; each pair of the elements being connected in parallel.



# Control Units for Sound Recording

*Home-made and commercial units giving multiple use of the audio amplifier*

By GEORGE J. SALIBA, S.B.

**S**IMPLICITY of operation is absolutely essential in any apparatus that requires for its ultimate commercial success a great volume of sales to the general public. With the first radio sets, it took an experienced operator to tune in a station. The switches and tuning devices presented such a formidably technical appearance that the layman usually adhered strictly to the rule of "hands off!" It wasn't until single-dial control was developed that radio finally came into its own.

Fortunately for the home-recording enthusiasts, the present-day manufacturers of recording equipment are so thoroughly educated to simplified control that not one of them is offering a control box which contains more than one knob; and the wiring-in of the box to the radio receiver is such a simple matter that it takes only a few minutes.

For home recording the control box must be capable of performing the following functions, using only a single knob.

- (1) Switch in the microphone circuit for voice recording;
- (2) Change the circuit for playback;
- (3) Connect the equipment for radio recording;
- (4) "Normal." (Radio reproduction at full efficiency.)

It is the purpose of this article to describe in detail some of the control boxes now available, starting with one which can be built easily in the home.

Fig. 1 shows the circuit of such a box. The switch Sw. 1 shown in the diagram is of the Federal "anti-capacity" type, obtainable at radio stores for a small sum. The four moving contacts of the switch are all rigidly connected together by an insulating strip, as shown; so that when the handle is thrown to the right, contact is made between the four moving contacts and the four

left-hand springs. When the handle is thrown to the left, the moving contacts make connection with all the right-hand springs. It is very evident, therefore, that the switch can control many circuits; and therefore it lends itself very nicely to home recording circuits.

The microphone transformer MT is of the conventional type. Two 200-ohm windings form the primary; while the secondary has an impedance of 200,000 ohms to match the grid-to-cathode impedance. The single-button microphone is shown as an example;

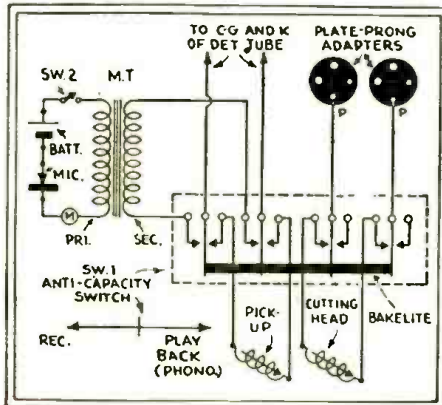

Fig. 1

A simple change-over unit for home-recording, using a standard multi-pole double-throw switch SW1; the adapters fit underneath the power tubes.

however, the use of a two-button microphone will improve the recordings. Connections for the latter were described in the July, 1931 issue of RADIO-CRAFT (page 28).

The operation of this control box is extremely simple. If recording is desired, the switch is thrown to the "recording" position, and the toggle switch Sw. 2 in the microphone circuit is closed. For microphone recording, the radio set is detuned, or the volume control is brought way down. If radio recording is desired, the microphone switch is thrown to the "off" position, and the desired program is tuned in. Playback is accomplished by throwing the switch to the "phono" position and breaking the microphone circuit. It is important to remember that, when microphone recording is not desired, the microphone switch must be "off"; otherwise the battery will run down rapidly.

It will be noticed that, in the "playback" position, the high-impedance pickup is connected directly to the grid and cathode of the detector tube, without using a coupling transformer. A transformer is not really necessary; because the quality is not improved in the least, while it means added expense. As a matter of fact, the effect

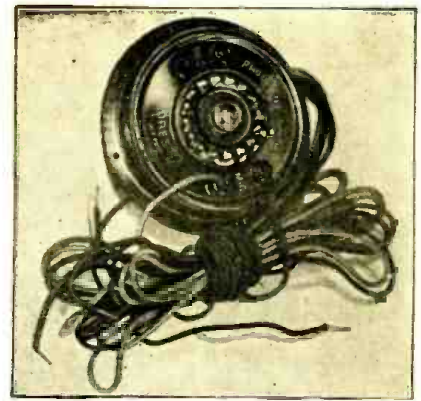

Fig. A

A new, compact unit for selection of circuits to record, play-back, or reproduce radio.

of the transformer would be to reduce the entire level of the higher frequencies; and this is detrimental to good quality.

In the writer's opinion the use of a coupling transformer is only permissible when the gain is low and warrants an increase; or when the leads are quite long. Lengthy, high-impedance leads are the cause of feedback and the picking up of line noises. To prevent this, a "low-impedance" pick-up, usually 200 ohms, is used in conjunction with a suitable input transformer.

When the switch is thrown to the recording position, a slight decrease in volume at the speaker may be noticed. This is due to the fact that the impedance match between the output tubes and the load, is destroyed. For maximum undistorted output, the plate circuit load impedance of a 3-element tube must equal twice the tube impedance; and, if an impedance equal to the normal load impedance is put in parallel with the latter, the output tubes will then "look into" an impedance only equal to their own. Maximum power transfer is now accomplished, though with a certain loss of quality and volume. However, this condition is not enough to have any noticeable effect on the finished record.

If single-prong adapters are not obtainable, the two wires are placed on the plate prongs of the output tubes.

The Presto control box shown in Fig. A, comes complete ready to be wired to the radio receiver. This box has on it three

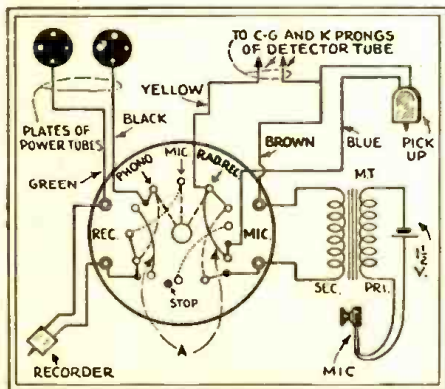

Fig. 2

A practical circuit incorporating the commercial circuit-change switch of Fig. A; both pickup and recorder units are required. Arms A take three positions.

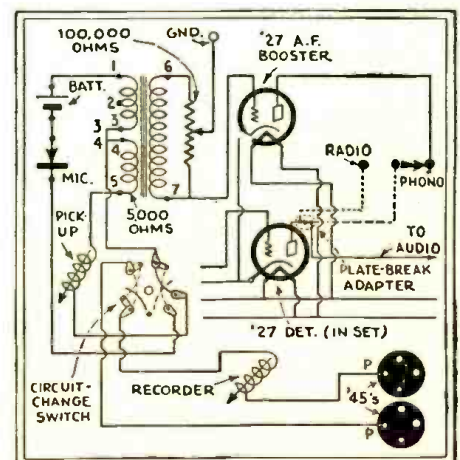

Fig. 3

Substantially, the circuit of Fig. 2, with a "booster" stage added to obtain better quality and volume, with less background noise.



positions, namely: "Radio," "Mic." and "Radio-Rec."

In Fig. 2 is shown the simplest way of utilizing this box. The selector switch is of very ingenious design and, from a close

ohm winding for the microphone, and a 5000-ohm (impedance) winding to match the pick-up. This hookup also provides a single-pole, double-throw toggle switch for radio or phonograph, eliminating the neces-

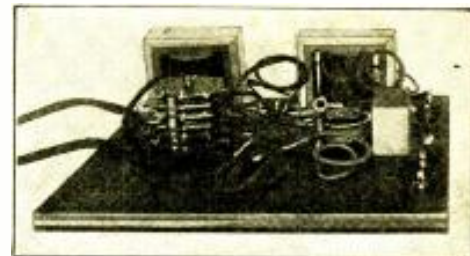

Fig. B

Interior view of the Best control unit, operation of which is shown in Figs. 4-8 inclusive, on page 180.

### THREE PRIZE-WINNING NEW WORDS

For Sound Recording Technicians and Fans

No. 1

The Professional Operator of recording equipment should be called a **RECORDING TECHNICIAN**

Prize of \$10.00 won by James J. Bolger, 706 George St., Norristown, Pa.

No. 2

The Non-Professional Owner of a recording radio is a **SOUND FAN, or SOUND HAM.**

Prize of \$10.00 won by Mrs. Karl Nash, 1125 Graydon Ave., Norfolk, Va.

No. 3

The person whose voice is actually being recorded is a **REPRODUCEE.**

Prize of \$10.00 won by Joseph Gomery, 357 Crane Boulevard, Los Angeles, Calif.

While quite a number of new words were coined for the contest by our readers, the general run of these inventions were unsatisfactory because they were either hard to pronounce, or not quickly suggestive of their meaning. "Recorder" was offered in each of the three contests; obviously, if the most suitable word for one purpose, it is not so for the others. "Phonologist" and "Transcriber" were among the entries for No. 1 which deserve honorable mention. "Recording Subject" and "Recording Artist" were suggested for No. 3; the prize winner in which is not more satisfactory, for most purposes, than "Recorder," which was listed in the announcement of the prize contest (in the July, 1931, issue of RADIO-CRAFT) as being ruled out of the competition.

As usual, there were many suggestions which, though meant seriously enough, carried more or less humorous implications which had escaped the contestant. For instance, "Amacordaceiver," "Tyro-Sonographer" and "Radiolaysican" (No. 2); "Professographer" (No. 1); and "Accordist," "Lambdagaphter" (hi), and "Recorvocant" for No. 3.

Most of the attempts to form words on classical principles were not altogether happy; although one entrant wrote "Having derived these words from the Latin, I feel that they will meet the combined approval of the radio profession." That is, as Mark Antony might have observed to Caesar's ghost, a *non sequitur*.

We believe that words more acceptable to the profession and to the public may be coined, and will be; but, at present, the prizes must be awarded on the bases of the entries submitted in the contest, and under the terms laid down.

sity of detuning the radio set when microphone recording is desired.

From Figs. 2 and 3, it should be obvious how this control box operates. When the switch is in "phono" position, the pickup is connected directly to the grid and cathode. In "Mic." position, the microphone circuit and the recorder are cut in; the volume control of the set must then be turned way down, or the set detuned.

In "Rad-Rec." position, the microphone circuit is disconnected and radio recording is accomplished.

Fig. 4 is a schematic of the Best control box. The selector switch used in this box is made up of six circular plates of fiber which have connector lugs evenly distributed around their rims, as clearly shown in the photograph, Fig. B. Five of these lugs give selection; while the sixth, or common connection, is permanently attached to a circular metal ring which is fastened to the fiber disc. One end of the switch arm makes contact with any one of the five lugs, while the other end is always in contact with the circular ring.

There are six sets of these rotary switches. Each arm is individually insulated, but all are rigidly connected to the shaft; so that, when the control knob is turned, the arms move in unison. For example, when the arm is turned to "Radio" no connection changes are made and, consequently, the radio is free to be operated. When the knob is turned to "Radio-Rec." the circuit  
(Continued on page 180)

study of the diagram, the various operations will be evident. Seven contacts are distributed about the periphery of a circle; one stands alone while the remaining six are strapped together to make 3 pairs. The arm of the switch is made up of two arc-shaped metal strips A, which are insulated from each other.

On the top of the box are provided two pairs of phone receptacles; one for the microphone and one for the recorder or cutting head. Five wires from the box are connected permanently to the radio receiver: the black and green to the plates of the output tubes; the blue to the pick-up; the yellow to the grid of the detector; and the brown serving as a common lead to both the cathode and the pick-up.

A more elaborate use to which the box may be put is illustrated in Fig. 3. Here a microphone amplifier or booster is shown; this is for radio sets which do not have sufficient gain in the audio stages for good recording. The microphone transformer used is, preferably, of special design, with a two-section primary consisting of a 200-

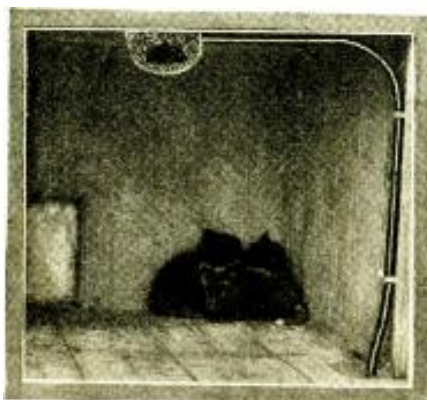

Above, cubs, with a wire-guarded microphone in their kennel. Below, the central amplifier, with selector switch and loud speaker, used on the Silver Fox Farm, Kirchberg zu Tünshütz, Eisenbera (Thuringia), Germany.

With a multiple-microphone and central amplifier system, the fox breeder listens on his temperamental proteges.





# Going After Service

*How advertising and publicity rebuilt a business rapidly for an enterprising Service Man*

By J. P. KENNEDY

**O**UT of the game for a year. Your business wrecked in the midst of a national economic upheaval: everything to win, nothing left to lose. Would you go under or fight? That was the question I faced a year ago and chose to fight. You can do some shrewd thinking when you're hungry.

The first problem requiring thought was to reach the greatest number of people with the message, not only that a radio Service Man was available, but that they needed this particular Service Man right now. Under the mistaken idea that low prices would get the results, five hundred government post cards were printed and sent out offering service at one-third the regular rate of \$1.50 for a limited time. The idea practically failed. The "something-for-nothing" people were the only ones that called; and they wanted more for their fifty cents than two ordinary calls would entail.

The next idea had more merit and certainly more profitable results. The radio page of our leading local paper was such an uninteresting sheet that most of the radio advertisers requested other locations to make their copy effective. "Let's write something of interest for that page, something that will consistently attract readers who, in turn, will see the ads." That idea appealed to the editor. He offered to run free with my name at the head, a daily column on radio, if I would supply the copy.

A question and answer column seemed the logical medium and, as enough questions would not come in to supply the daily assignment, it would be necessary to write

not only the answers but the questions. To make them appear genuine, fictitious initials could be signed. It took six hours of typing to prepare the first two weeks' copy. The idea clicked instantly. Actual fan mail began to come in with real questions. People began to ask, "Who is this chap, Kennedy?" Sensing that query, I ran ads, tying in with the column, with my picture and suitable copy. The calls for service were increasing daily.

### A Direct-Mail Campaign

There are a large number of wealthy people in this city (South Bend, Indiana). Their trade and good will was the next objective. Tortured with staid mimeographed advertising, that went in the waste basket,



Telephone 3-2414

**J. P. Kennedy**  
418 West LaSalle Avenue  
South Bend, Indiana

**J. P. Kennedy's Radio Service**

Dear Mrs. Riley:

The gentleman whose picture appears on this card will call on you in a few days to test and check your radio set.

This service is absolutely free. We want to know what type of set you have and what equipment it takes so that when you call for service we can serve you without delay. Please admit Mr. Kennedy when he calls.

J. P. KENNEDY'S RADIO SERVICE  
418 West LaSalle Avenue,  
South Bend, Indiana.

Ph. 3-2414

A postal with a picture, like the business card above—a two-color job which has suffered in reproduction.

**What's Wrong With Your Radio?**  
BY J. P. KENNEDY, Instructor of Radio and Service Engineer.

**Profit by Experience**  
OF 2,000 OTHERS, CALL  
**J.P. Kennedy's Radio Service**  
Ph. 3-2414, 418 W. LaSalle

**OUR COMPLETE KNOWLEDGE OF RADIO MEANS MINIMUM COST OF REPAIR.**  
**J. P. KENNEDY'S Radio Service**  
Ph. 3-2414 418 W. LaSalle

**What's Wrong With Your Radio?**  
BY J. P. KENNEDY, Instructor of Radio and Service Engineer.

**\$10.00 FREE**  
If We Can't Repair Your Radio Set  
**J. P. KENNEDY'S RADIO SERVICE**  
Ph. 3-2414 418 W. LaSalle

**What's Wrong With Your Radio?**  
**J. P. KENNEDY'S RADIO SERVICE**  
Ph. 3-2414 418 W. LaSalle

A combination of publicity and advertising with small space—"bullets"—frequently repeated. Larger newspaper advertisements are shown below at the left.

**DANGER from LIGHTNING**  
Striking your radio aerial eliminated. Special this week only, a regular \$1.50 lightning arrester installed for only \$1.00. Comply with your FIRE insurance requirements. (All sets we have installed are protected.)  
**YOU CAN LAUGH AT LIGHTNING**  
If you phone  
**3-2414**  
**J. P. Kennedy's RADIO SERVICE**

**Your Wife and Family Deserve Lightning Protection**  
Lightning Arrestors Installed  
This Week Only  
**\$1.00**  
Regardless of where you bought your radio, employ  
**J. P. Kennedy's RADIO SERVICE**  
Phone 3-2414  
418 W. LaSalle.

**19 Doctors, 12 Lawyers, 4 Presidents**  
Of local corporations, and many other prominent men, noted for their discrimination and judgement, consistently employ  
**J. P. Kennedy's Radio Service**  
418 W. LaSalle  
**3-2414**  
For Economical Results.

The "ad" at the left was less successful than that in the center, which introduces "human interest."

these people are the hardest to reach. Personal calls are impossible with countless butlers, maids and private secretaries to block reaching their superiors.

Personal letters seemed the only solution. They must be sent in plain envelopes on plain white paper, with no letter head that would betray their commercial aspect. They must have human interest, discreet flattery, the personal touch, and a dynamic compact message—high-pressure stuff. Everyone who has lived in a given community, for a few years, knows at least the big civic and industrial characters. If not, almost any old citizen can supply not only the names but countless stories and incidents about these prominent people. There is your material. A typical letter appears on the next page.

### Use of Good Printing

The problem of boiling a compact forceful selling message into a one-inch, single-



column newspaper ad cost several hours study. The most effective of several dozen tried are reproduced here.

An important part of a Service Man's equipment is a good business card. Taking advantage of the methods used by politicians to get their personality across to the voters, I resorted to a business card bearing my own picture and a minimum of printed material. The more simple and unique the card is, the more dignified and effective it is with the most desirable class of trade.

Study the business cards of successful firms and men. Ask yourself what appealed to you in a particular card; take that idea and use it in your own card. Color, discreetly used, distinguishes a card. I use two straight blue lines (despite the extra cost of a second run by the printer) to get away from the conventional black, yet employ a cool color that will not distract the eye of the reader from the printed matter. I consider this card on a par with

**KENNEDY'S J. P. RADIO SERVICE**

**PERSONAL  
HIGH QUALITY SERVICE**

Reasonable  
Rates

418 W LaSalle.....3-2414

*An advertisement in the classified telephone directory attracts attention at the right moment.*

any other form of advertising I could give a prospective customer.

To supplement the business card, a personal letter of appreciation goes to every new acquaintance I make. It apparently does no harm to flatter new friends; they remember you long after you have forgotten them.

Studying the successful method of selling employed by allied industries, I took the idea of the persistent Fuller Brush salesman and reworked it to sell service. The addresses of houses having an aerial could be secured by merely walking down the street. The city directory supplied the names of the occupants of these homes. I selected ten a day and mailed a government postcard bearing my picture and the message reproduced on the preceding page.

This announcement has been gaining entrance to 70% of the homes it is sent to. True, it costs time and energy to make these free calls; but half of those called on need new tubes, lightning arrestors, tone controls or actual repairs and—believe it or not—they buy them and average you \$1.50 to \$2.00 per call. The days when you could sit around the shop, and wait for the calls to come in, have passed. There is plenty of business if you go after it.

I tried an interesting experiment in selling lightning arrestors. The weather reports were watched carefully for an announcement of an approaching thunder storm; and an ad was then run with a scare headline in italics. *Not a single call resulted from the ad!*

The copy was changed, a little personal family interest was injected; and not only was a stock of slow-moving lightning arrestors sold, but I obtained the opportunity to sell tubes and other accessories on the same call.

**Telephone Solicitation**

On rainy days, and particularly in the evenings, it is profitable business to call old customers, who have not been contacted for six months or more, by phone. Offer to test their set free the following day while you're in their neighborhood. (Of course you make it a point to be in their neighborhood.) It is absolutely surprising how many type '45 and '80 tubes are sold on these calls.

The phone book provides an invaluable advertising service. Snappy copy that shows class, yet does not frighten away the financially timid reader, can be run in the business directory part of the phone book at low rates (compared to other advertising mediums) and you know that it is within reach of all your more desirable customers, day and night throughout the year. Where two phone books are issued per year, that which covers the fall period should have the largest and best copy you can afford to run; while just a simple card-like announcement will do in the book during the period of least activity in service work and during the time you are going out after the business. I intend to have copy in the phone book as long as I am in the service business.

A copy of a small-type phone book ad is given here.

The natural question other Service Men will ask, when they finish reading this article, is: "How much is Kennedy making with all these advertising stunts? How big is the city he's in?"



*Mr. Kennedy has designed his own service equipment: above, an analyzer which is kept up-to-date; right, shop equipment. The 1000-cycle oscillator has plug-in coils to cover 170 to 6,000 kc.; it incorporates a galvanometer, for a grid-dip meter. There is also an 0-10,000 ("decade" adjustment) ohmmeter; a 0.1 to 3.9 mf. capacity meter; and a milliammeter which reads 0-10-100-500 volts. Every unit has phone jacks, for quick connections with proper polarity.*

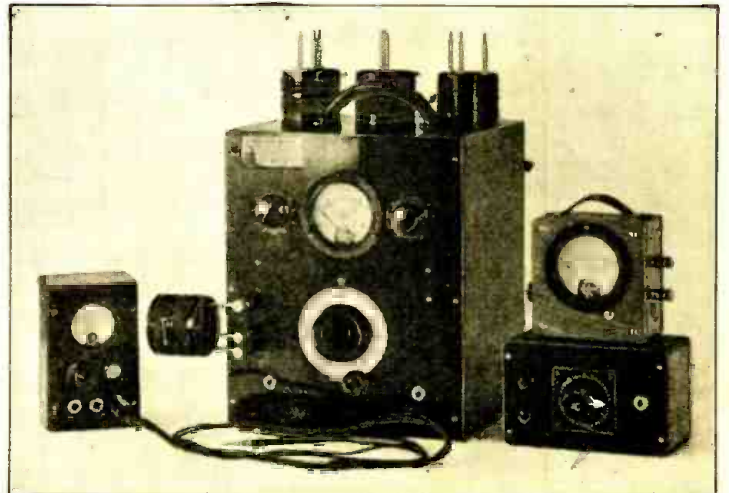

418 West LaSalle Avenue,  
South Bend, Indiana  
October 1, 1930.

Mr. John Riley,  
605 E. Howard Street,  
South Bend, Indiana.

Dear Mr. Riley:

Have you ever had a person that sold you merchandise or service take a personal interest in your satisfaction after they secured your money?

A few years ago, I had the pleasure of repairing your Bremer-Tully radio. The gracious manner in which I was treated by both yourself and your charming wife left a pleasing memory. The air of culture and refinement that pervaded your home inspired me to exert my best efforts and utmost skill in repairing your radio.

Not hearing from you since, I presume your set has been working satisfactorily, but really it should be carefully gone over at least once a year. Tubes don't last forever. Improvements are available, such as static modifiers, better known as tone controls, new quick heating tubes and more efficient lightning arrestors.

I am interested in your satisfaction. Without knowing of these improvements, you might be talked into buying a new set, while your present set can be brought up to date at a fraction of the cost of a new machine. I want your friendship and the good will of your friends. This can only be obtained by serving your interests to the best of my ability. In other words, I want your radio service business. May I have it?

(Signed) J. P. KENNEDY,  
J. P. Kennedy's Radio Service.  
Phone 3-2414

*One of Mr. Kennedy's diplomatic letters. A little blarney, and then a business touch.*

The business will average \$10.00 a day profit or return for labor while you work. Being human, I take a day off occasionally for a little golf; devote a few evenings a month to social affairs (there are some beautiful girls in South Bend and they are partial to young men in business); oversleep some mornings; attend the weekly meetings of the Kiwanis Club and take part in any civic affairs that call for volunteers. (That's real publicity plus the satisfaction of doing a good turn.) South Bend is an industrial city of slightly over 100,000 population, with a fine friendly group of people and with the well-known University of Notre Dame at its northern boundary.

The leading radio concerns have distributors located here who supply all the standard merchandise needed, without delaying

*(Continued on page 182)*



# DESIGN OF Oscillators for Servicing

## A STABLE-FREQUENCY OSCILLATOR

By C. H. W. Nason

THE oscillator described here has been used by me for many varied purposes, for some years past, and gives stability of calibration to a marked degree. Although it is not generally known to the layman, the voltages supplied to an oscillating vacuum tube have a marked influence on the frequency of oscillation, by reason of the changes in the tube constants arising as the voltages shift: this holds true for both "A" and "B" potentials. It is also true that, in most circuits, the changing of tubes will require recalibration of the circuit. In the oscillator shown, the tuned circuit, controlling the frequency of oscillation, is so completely isolated from the tube circuit proper that changing voltages or minor changes in the tube constants have but little effect on the calibration of the oscillator; and the frequency will remain constant within a small fraction of one per cent. over long periods. I have never had the opportunity of testing the arrangement in short-wave transmission, but have employed it in special measuring circuits to as low as 40 meters where, to all intents, the stability of frequency was as high as could be obtained from quartz-crystal apparatus without temperature control.

In aligning the tuned circuits of a receiver, it is not necessary to employ a modulated oscillator together with a rectifying output meter; for the detector tube of the receiver itself gives an excellent indication of the maximum signal when arranged as a vacuum-tube voltmeter. All that is necessary, to make the detector operate as a tube voltmeter, is to make provision for an indicating instrument; which may be a 0-10-milliamperere meter inserted in the detector plate lead. This may be done, either by definitely breaking the detector's plate-supply lead, or by using an adapter

(manufactured from an old tube base and a socket) in which the plate lead has been brought out to form a connection for the meter.

An important difference between grid-leak and bias detection will become obvious immediately. In grid circuit or grid-leak detectors, the plate current is normally quite high for the plate voltage used; since no bias, or a slightly positive bias, obtains. In this type of detector, maximum signal is indicated by the minimum detector plate current. The contrary is true of plate circuit or bias detection, where the grid is biased almost to the cut-off of the plate current, and the maximum signal is attended by the maximum detector plate current.

The procedure in ganging the tuning condensers of a receiver will be quite simple. It is necessary only to set the tuning control of the receiver at some fixed point and vary the oscillator (coupled, of course, to the antenna lead by means of a single turn of wire; or, through a small condenser—about 100 mmf.—to the antenna post of the receiver) until a maximum reading (or

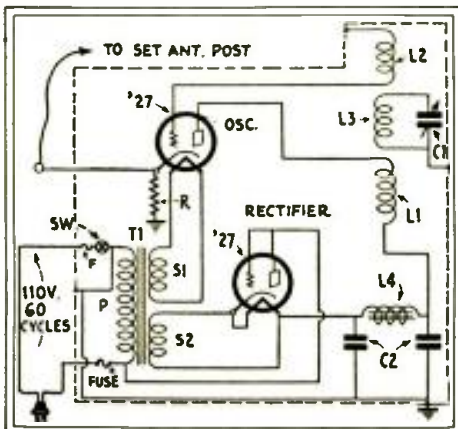

The stable-frequency oscillator described by Mr. Nason is tuned by L3-C1, which is not in the circuit of the tube itself.

minimum, as the case may be) of the indicator is obtained. Each tuned circuit should then be varied by means of the trimmer condensers, or by adjusting the condenser plates, until maximum signal is obtained. Much sharper adjustment of the circuits can be obtained with an oscillator of this type than with a modulated oscillator—although it must be admitted that this gives no check on the audio amplifier. Any difficulty experienced, in obtaining a sharp indication of the maximum signal, points to detector overload; and the coupling between the oscillator and the receiver should then be reduced.

When it is desired to calibrate the oscillator, one may select broadcast stations of known frequency (almost all stations are close to their assigned frequency these days) and adjust the oscillator to the frequency of the broadcaster by the "zero-beat" method. To do this, tune in the station desired, vary the oscillator until a heterodyne note is heard in the speaker; then carefully reduce the pitch of the note until the heterodyning disappears. The oscillator is now adjusted to the same frequency as the broadcaster. Only a few stations need be used to obtain enough points to draw a full-range curve of the oscillator's tuning range.

Service Men and fans competent to use this equipment should be quite capable of

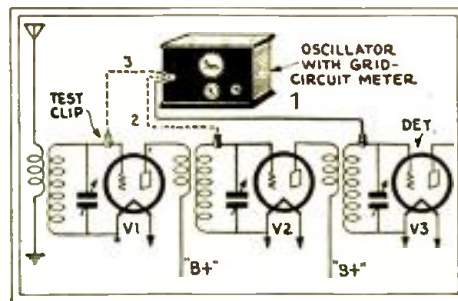

Fig. 1

The usual method of applying a single oscillator successively to R.F. circuits.

ts construction without details as to layout. The parts required are as follows:

- One transformer with two 2.5-volt secondaries (T1);
- One Hammarlund "SLF 17" .00035-mf. condenser, with dial (C1);
- Two Polymet 2-mf., 200-volt bypass condensers (C2);
- One iron-core choke, 30-henry (L4);
- One Electrad 1000-ohm flexible resistor (R);
- One grid coil (L2), 40 turns on a 1 1/2-inch tube;
- One plate coil (L1), 40 turns on a 2-inch tube.

One tuning coil (L3), 80 turns on a 1 3/4-inch tube. The three coils are assembled, one inside the other, in the order of their diameter; all are of No. 25 enamelled wire. The completed oscillator must be totally shielded.

## USE OF DUAL OSCILLATORS

By A. R. Haidell

IF the accumulated experience of all Service Men were known to each Service Man, considerable time and expense could be saved; but the practical short-cuts and inventions of one may not occur to others. The following practical hints may be of value to you.

There are various methods employed to line up the R.F. stages of broadcast receivers, but many of them leave much to be desired. One rather common arrangement for adjusting the various stages is shown in Fig. 1, where we have an oscillator and a grid meter in series with its grid leak; the complete circuit of the oscillator being given in Fig. 2.

In lining up the various stages, the test clip is connected to one of the tuning condensers and the oscillator's frequency is varied for minimum grid current.

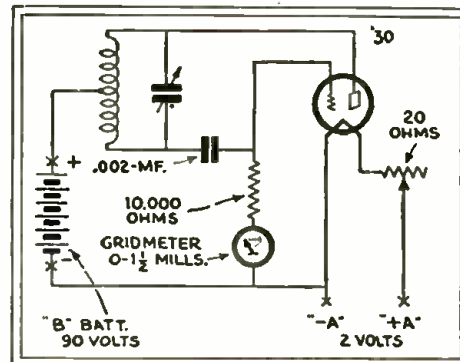

Fig. 2

Design of the oscillator described by Mr. Haidell; coil and condenser are any combination suited to the band to be tuned.



The compact and convenient design of Mr. Weiler's original oscillator (See page 147.)



# Favorite Testing Equipment of Service Men

## A COMPLETE TEST BOARD

By W. L. Brown

THE test panel illustrated, installed in our service department primarily for our work with Crosley receivers, incorporates many special features. It is specially provided with equipment for servicing D. C. and automobile sets, etc.; will test Merphon condensers; determine gain of audio amplifiers; detect a short in a variable condenser without disconnecting the R. F. coil; measure the current consumption of a chassis; etc., etc.

The center panel will be recognized as a Supreme Diagonometer ("Model 400 B") the external connections of which are brought out below. The small square panel at its left is a tube tester constructed in our own shop; above it is a heater rack, used to warm up cathode-type tubes before they are put on test. At the right of the Diagonometer is a completely shielded, modulated R. F. oscillator; and beyond this is a "Model 706" ("Showbox") rewired with '45s, for use as a master set in testing reproducers.

The panel is provided with a special heavy power transformer of our own design, for operating the heater rack, and furnishing direct current for heavy-duty tests. It now has also, at the left, a multiplug and volume control, with a special cable for tests with the "Roamio" automotive set; to this, batteries are connected. This connection, however, is not shown in the illustration. To the three speakers pictured, also, have been added two more.

On each end of the panel are A. C. connections, glow lamps with pin-jack connections for continuity tests; antenna connections; and pin jacks giving access to the speakers above. It is possible for two

(Continued on page 174)

Ordinarily, the first condenser used is one having no adjustment; if the set employs three tuned stages, and only two are provided with trimmers, the condenser without a trimming condenser is used first, other stages being lined up with respect to it. With minimum grid current, the test clip is moved to the condenser of an adjacent stage, and the trimmer is varied until the grid current again is at minimum. This procedure is repeated until all the stages have been lined up; then the whole process should be usually repeated, for best results.

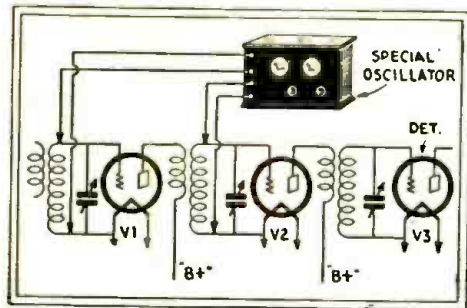

Fig. 3

Mr. Haidell uses two oscillators, built in one cabinet, to detect difference of tuning between two R. F. circuits.

The essentials of a new arrangement are shown in Fig. 3; this set-up is inexpensive and will save considerable time. Two simple Hartley oscillators are necessary; the new two volt ('30) tubes are suitable. Each oscillating circuit is provided with two leads with clips; and both oscillators are mounted in the same cabinet and adjusted to cover the same frequency range, as shown later.

To operate, set the clips on the condensers of two adjacent stages. The trimming condenser of one stage is then varied until zero beat is obtained in the loud speaker, or in the headphones connected in the plate circuit of one of the oscillators. Both oscillators should be oscillating at the same frequency, before they are connected to the stages. When connected, they will still oscillate at the same frequency, if each tuned circuit in the receiver is tuned to the same frequency. Hence, when the tuned circuits are lined up, zero beat between the oscillator frequencies will be reached. The signal in the loud speaker may be as loud as desired, making for easy adjustment. The volume control should ordinarily be turned down.

When the first two stages are properly lined up, the leads are changed over to the next pair of tuned circuits and then the latter are adjusted. It is clear that a closer approach to the desired condition of resonance will result by adjusting two stages at a time, and much time will be saved.

The cost of the necessary equipment is less than in the ordinary arrangement; for the grid meter or plate meter, which is quite a fraction of the total cost, can be left out.

Matched coils and condensers should be used in the two oscillators. Each oscillator is adjusted with the same tuned circuit, so that the minimum constants are the same; one of the condensers can be adjusted with a trimmer, if desired.

The Service Man usually employs some special points on the dial of the receiver which is to be lined up; one of these is selected, and one of the oscillators is ad-

justed to some setting near the natural frequency of the tuned circuit in the receiver. A pair of headphones is then connected in the plate circuit of the other oscillator, and the dial is adjusted until zero beat is obtained with the first oscillator.

With both oscillators operating on the same frequency, the leads are connected to the tuned circuits in the receiver; and the trimmer in one stage is adjusted for zero beat in the loud speaker, or in the phones. When the leads are clipped on the tuned circuits the frequency of the oscillators will, usually, change. It will be noted that the oscillator and receiver coils are in parallel as are, also, the oscillator and receiver condensers. The total inductance is thus halved and the capacity is doubled, leaving the frequency of oscillation nearly the same.

## A PORTABLE ELECTRIC OSCILLATOR

By H. Weiler

COMPACT and light, the unit shown can be operated from the 110-volt line without the use of rectifiers, step-down transformers or filters.

Rectification in this circuit (Fig. 4) is automatic because the grid is negative only when the plate is positive; when the reverse is true, obviously, no plate current is flowing. We also use this continuous reversal of current (in the A.C. line) to modulate

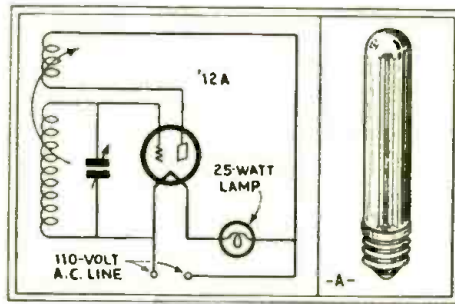

Fig. 4

Mr. Weiler's simple oscillator; right, a type of 110-volt tube which gives great compactness.

our signal, for 60 cycles is an audible frequency.

When a '12A type tube is connected in series with a 25-watt lamp in a 110-volt line, we get approximately 5 volts on the filament.

The value of the condenser is .0005 mf.; the coil was an ordinary three-circuit tuner. The secondary shunted across the condenser is wound with 48 turns of No. 26 S.C.C. wire on a 2 1/2-inch tube. The amount of turns to be wound on the tickler is to be determined by experiment.

(Continued on page 175)

Mr. Brown, left; Mr. E. A. Freitas, right; with the test board described above; which was constructed for the service department of Kierulff and Ravenscraft, Los Angeles, of which the former is manager.

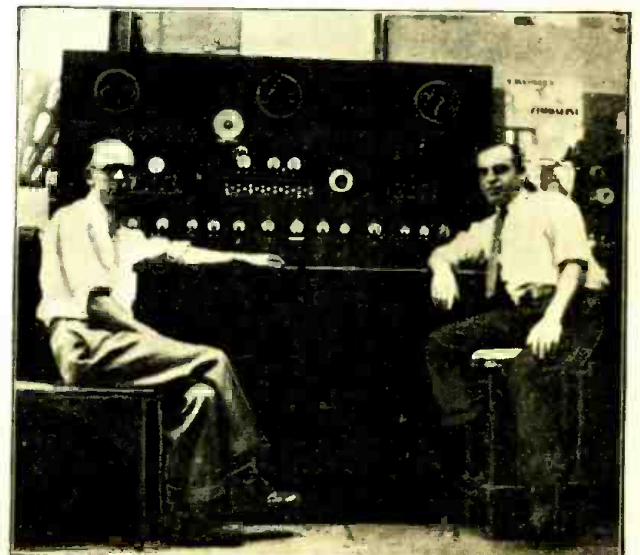



# The Sonora Specialist

Service data on these widely-distributed and complex receivers

By GEORGE F. BROOKS

**S**ONORA receivers were extremely popular, and a great many of them are still in operation, presenting problems of servicing which are out of the ordinary in some ways. For this reason, the writer has combined all his experiences with the receivers of this make, to describe a thorough routine of service inspection and adjustment of a "Model 40" phonograph combination; although it is not to be supposed that all the troubles listed will be encountered in a single set.

The following list of complaints may be presented:

- (1) Distortion on radio and phonograph, with lack of bass notes;
- (2) Radio fades out, but can be brought back by snapping switch;
- (3) Weak signals on the phonograph;
- (4) Radio will occasionally start up a bubbling noise (motor-boating);
- (5) Unevenness of sustained notes on phonograph recordings;
- (6) Phonograph motor interferes with radio reception (brush-type motor);
- (7) Noisy volume control on radio;
- (8) Phonograph motor will stop before end of records;
- (9) Oscillation on radio at 350 meters and 500 meters;
- (10) Excessive hum.

A test of tubes may show that one of the SO-1 push-pull power tubes is inoperative; so that the other receives an increased plate voltage and, with the lower current flow through the biasing resistor, lowered negative bias. The result will be that the plate current of the remaining tube will be too high; and this is one cause of the distortion, in radio or phonograph reproduction, listed as point No. 1.

### Overhauling the Tuner

After replacing defective tubes a test for fading (No. 2) may be made. With the analyzer plug in one of the R. F. sockets, it is found that the plate current is increasing and the grid bias decreasing, while the signal is fading out.

The probability is that the 0.1-mf. coupling condenser (see below) between the plate of one R. F. amplifier and the grid of the next is leaking; this gives the grid a positive bias, and prevents the tube from functioning as an amplifier. These condensers are of the paper type, and subject to deterioration as a result of the heat of the tubes. It is advisable to replace all of them with the bakelite-encased, mica-dielectric type but, since each condenser is located under its tube socket, it will be necessary to take off the bottom of the tuner unit.

This may be pulled without disturbing the audio unit, by taking off the dial plate; but it is necessary also to disconnect the tuner's cable from the terminal strip behind the audio unit, and pull out the extreme left phonograph record rack to remove the bolt directly above the latter. This bolt holds the left side of the tuner; while the bolt at the right side is accessible from the rear of the cabinet, just above the reproducer.

After unsoldering the pilot-lamp leads, the tuner unit may be taken out. While replacing the coupling condensers, the opportunity is also obtained to tighten up the screws holding the neutralizing chokes to the chassis. These chokes, which are under the coil sockets, are part of the neutralizing system and must be properly grounded; or instability will result. The chokes under the tube sockets, on the other

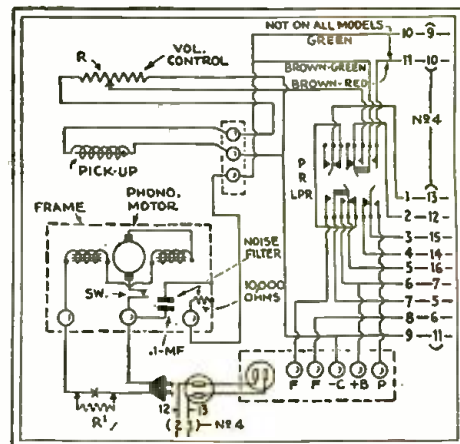

Phonograph unit of Sonora "Models 44," "46," and "40." Color code of tuner, all sets (below): 1 to 6, respectively: green; red-blk.; black; blk.-yellow, yellow, yellow-blk.

hand, are in the plate leads; if one opens, there will be a lack of voltage on its R. F. plate.

Before reassembling the tuner, the contact arm of the volume control should be cleaned and a little oil applied, to cure the noise complained of as No. 7.

A reversal of the antenna and ground leads will cause hum (No. 10) as well as oscillation at 350 and 500 meters (No. 9); but hum remaining after this is corrected may be cured with a one-microfarad condenser between terminals No. 6 and 8 on the strip behind the audio unit. This bypasses the grid-biasing resistor of the R.F. and first A.F. stages. Hum remaining after this may be attributed to a shorted air-gap in one of the filter chokes of the power pack.

If there is no voltage on the detector plate, the black 60,000-ohm resistor under the audio unit is open. In this chassis, the detector plate voltage is tapped off the plate of the first audio tube through this resistor, which serves also as an A.F. stabilizer.

### Adjustments on the Phonograph

There are several possible causes for weak reproduction on the phonograph (No. 3) which will be taken up in this order.

The single-turo secondary of the output transformer (in the reproducer) is a copper band around the transformer. If corrosion

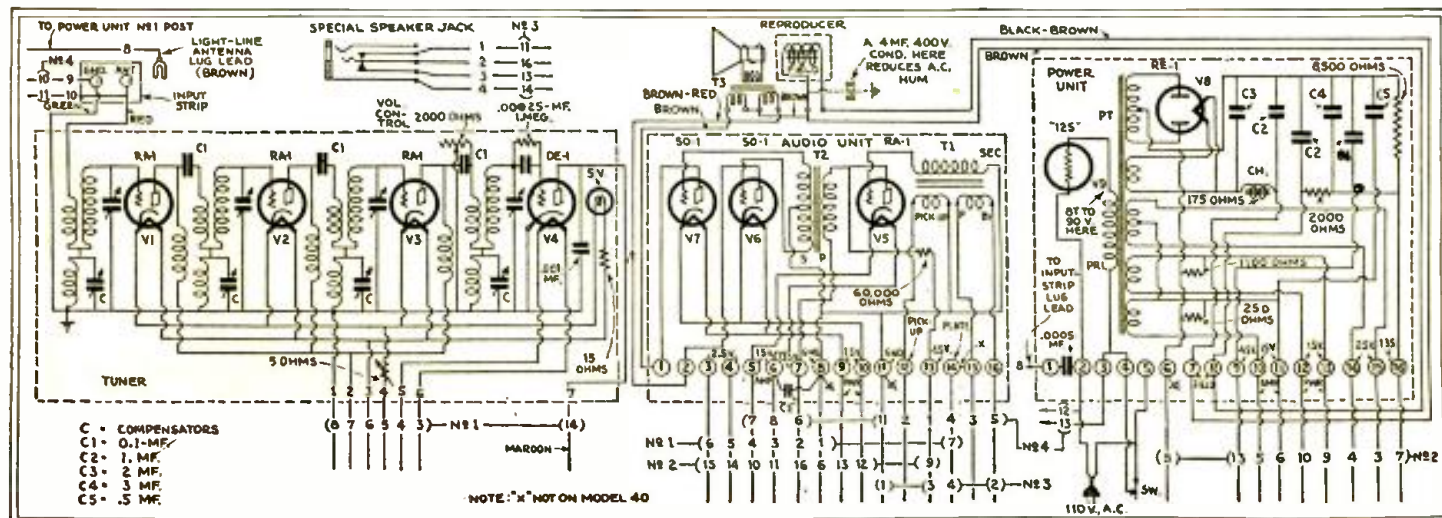

Fundamental arrangement of four Sonora receivers. "Model A-36" connects cables 1, 2, 3 between tuner, audio, power, and switching system (see page 173, upper left) units; "Models 44" and "46," cables 1, 2, 4, between tuner, audio, power, and phonograph (diagram at upper right) units; Model 20, cables 5, 6, between audio, power, and phonograph (page 173, lower right) units. Resistor R is 15-ohm; R1, is only in D.C. sets; pickup is of "low impedance" type.



causes high resistance, this band should be disconnected from the voice coil, and the contacts cleaned. This will restore sensitivity, particularly on the high frequencies.

If the cone is not centered properly, it is necessary to loosen the group of five bolts and readjust it.

The radio-phonograph switch points also provide a place where poor contact may be found. To attend to this, it is necessary to remove the motorboard. First take out the automatic spring holding the lid of the phonograph compartment; neglecting this will cause damage to the cabinet and to the mechanism. Disconnect the A.C. plug and the pickup leads from the rear of the cabinet.

The contacts are then cleaned with a small file, of the type used for automobile ignition work; the leaves are bent to increase the tension on the contacts. The phonograph volume control, which is a 15-ohm potentiometer across the pickup, is also sandpapered; since any imperfect contact will materially reduce phonograph volume.

Before replacing the motorboard, it is desirable to see that the filter unit on the A.C. line to the motor is in good condition. If the resistor is open, this will cause radio interference when the motor is running (if not to the set owner, at least to his neighbors—No. 6).

Before replacing the turntable, check up on the governor. Uneven running (No. 5) will give the optical illusion that the governor balls are square. To cure this, loosen the screws holding the governor springs and, holding the balls tight to the shaft, turn in the screws again. There is, at one end of the spring, an oval hole to take up slack.

If the governor shaft is held too tight in its bearings, it will be necessary to loosen the set-screw at one side of the outer bearing, and adjust the tension nut to allow about 1/4-inch end play. The end spring will hold the shaft steady in operation.

Stopping before the end of the record (No. 8) is quickly cured. While the turntable is out, slack off on the three bolts holding the motor, and twist the motor assembly counter-clockwise. This will change the cut-off point of the automatic stop, and the records will play through to the end.

Since this last operation affects the speed of the turntable, it will become necessary now to readjust the speed to 78 revolutions per minute. If the speed indicator shows "Min." before the speed is sufficiently reduced, bend the brake-pad holder slightly toward the balance wheel. This will check the speed; and the indicator is again readjusted until the operation is correct.

#### Ballast Lamp a Guide

Trouble in the power pack may be indicated by a bright glow in the ballast tube; normally this tube gets hot, but glows only dimly, if at all. A short of any of the filter condensers will light this tube brightly; while a short in the primary of the power transformer will blow it out.

To localize trouble in the pack, disconnect leads No. 7 and 8 from the terminal strip of the pack; these connect to the field coil of the dynamic reproducer, which also serves as a filter choke. Then test the transformer, filter choke and condensers for shorts. See whether the pilot-lamp bracket is shorted to the housing of the tuner.

(Continued on page 182)

# Servicing—As Others See It

*A viewpoint of radio retailing methods which is entirely too typical*

"IS this a system?" inquires a writer in *The Composing Room*, organ of a group of trade compositors (whom the general public would group under the generic name of "printers"), and he adds the following outside view of the radio business (retail):

"Recently we went through the experience of shopping for a radio. We didn't get one, thank God, but we did get a lot of information. We had thought that a radio was a device for collecting sounds out of the air and reproducing them in the home. In this we were mistaken. A radio, we now know, is an empty wooden box with a knob on it. The several hundred assorted gimmicks necessary to make the instrument do anything, are all extras.

"This business policy, if anyone could call it that, of radio distributors, strikes us as a pretty coy system. It could be applied to other lines of business and it occurs to us that the result would be no end amusing.

"If we had a radio salesman at the head of a typographic house, we would be somewhat startled, no doubt, by the way he would conduct the business. "Type at Five Cents a Thousand Ems," is about the way the advertising would run, and after several thousand printing buyers had been killed in the rush, the survivors would wake up with bills in their hands which would make them wish they, too, had died.

"To be sure, the job would be billed at five cents a thousand ems, but there would be a few little incidentals, not mentioned, of course, until after the contract had been signed. There would be an extra charge for composition; a charge for leads and slugs and for the spaces between words; a charge for metal; a charge for the compositor's time; a charge for the soap with which he washed his hands after the job was set; a charge for laundering his towel and apron; a charge for wear and tear on his shoe leather and an assessment for his old-age pension; a charge for ink, paper and time required for pulling proofs; a charge for depreciation on the proof press; a charge for string and paper used in tying the job up; a time charge for tying and weighing and an additional per cent. for upkeep for the scales; a charge for elevator service; a charge for delivery, including gasoline and oil and the truck driver's time; a charge for return of delivery truck; a charge for sweeping the office and, no doubt, a few other small charges, just for good measure.

"By the time the buyer got it in condition so that he could make any use of it, his thousand ems would cost him, according to the radio system, \$94.67, provided he returned the metal at his own expense."

The rather interesting point, that is most obvious here, is that the expenses listed are part of the cost of producing the composed type; after all these have been incurred, the type is useless until it has been put on a press and ink and paper applied

to it. In other words, the finished "composition" is like the radio before the latter is supplied with tubes and hooked up.

But this highly technical, if important, point is aside from the fact that the innumerable expenses of doing business must go into the cost of selling every radio; and that every radio dealer must take them into consideration. So also, all the costs of keeping a radio in operation must be paid by someone. The more difficult that service is made by the manufacturer, the more the public must pay for it. The more difficulties that are thrown in the way of the Service Man, the higher the cost of owning a radio. Rightly, or wrongfully, the public has the idea that the upkeep is too high.

It is an expensive frame of mind for the radio industry. A little more education of the public on radio servicing is in order; and it is most economically to be obtained by a somewhat more cordial *entente* between radio manufacturers and Service Men than that which exists today.

#### EXTENDING THE SPEAKER

By John J. Nothelfer

AT the height of a birthday party, the radio set suddenly went "dead"; a filter condenser had shorted. As the radio service stores were closed for the evening, it looked as if the party would spend the rest of the night in silence.

But, in a half hour, radio reception was restored in the following novel manner:

After a length of wire had been connected (through a 1-mf. condenser) to the plate of the last audio tube, in the next-door neighbor's radio, the wire was run to the home where the party was in progress. The magnetic speaker was then connected on one side to the wire, and on the other to the ground or chassis of the radio. As both receivers were grounded, the circuit was completed; and excellent reception was obtained for the rest of the evening. The wire used was only No. 24 C.C. magnet wire, and heavier wire would have improved the reception. This method of extending the output of a radio to another home has many uses, and many ideas can be developed from it. (The idea has occurred to other correspondents; but many readers may profit by it.—Editor.)

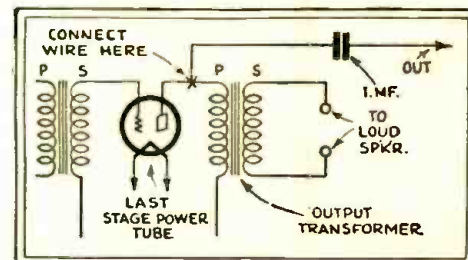

The expedient found by Mr. Nothelfer is simple enough; it is necessary, however, that there should be a good common ground between set and outside speaker.



APEX "MODEL 31" RECEIVER CHASSIS

("31-B," radio only; "31-C," phono. comb.; "31-D," remote control; 25-cycle models, "31-X" (radio only); "31-X Phono." and "31-X Remote")

The "No. 31 Series" Apex receivers, manufactured by United States Radio & Television Corp., Marion, Ind., include several developments of exceptional interest to the Service Man; outstanding is the design of the "Model 31 Remote," a remote-controlled screen-grid chassis. The detail illustrations show the manner in which the fundamental chassis arrangement is modified to obtain other modes of operation.

It will be observed that the 8,000-ohm volume control resistor is common to the antenna and cathode circuits of V1, V2 and V3. Its position in both Radio and Phono models is shown in Fig. A.

Modifications of the detector and power transformer primary connections, for phonograph operation, are detailed in Figs. B and C. The reproducer connections are illustrated in Fig. D.

V6, V7, 25 ma.; V8, 37 ma. (per plate). Screen-grid currents, V1, V2, V3, 0.45-ma. "Grid test," V1, V2, V3, 5.8-ma.; V4, 0.3-ma.; V5, 5.5-ma.; V6, V7, 30 ma.

The electrolytic condensers C, as a test of efficiency, may be checked for leakage at 250 volts D. C. Over a period of five minutes the leakage current through one 8-mf. section should be about 2 ma.; although it will function satisfactorily up to about 5 ma.

It is advisable to have the milliammeter shunted, and connected in the negative lead; if the meter does not indicate excessive current, the shunt may be opened and a more accurate reading obtained. This is good shop procedure; a more convenient one on the job being to open one of the positive leads, insert the shunted meter and, after five minutes (if the indication is normal) open the shunt for accurate measure-

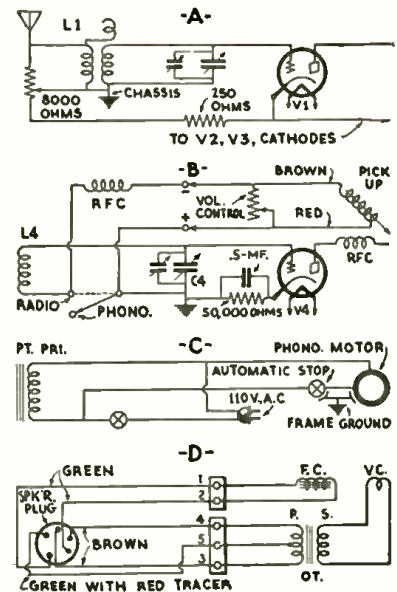

Figs. A, B, C, D, described in the text.

Of the 16 cabled wires, 9 are for station positions; 1, minus DX; 1, plus DX; 1, line lead; 2, volume control; 2, unused (they are "spares").

The operation of the remote box may be described as follows: Its 18-point selector is controlled by a knob. Pre-set station selection for 9 programs is available at as many contacts; 8 more are for "DX" settings; and 1 more, the "off" position. The arm of the switch is permanently connected to the line lead from the selector unit which goes to the secondary of T2; and its rotation completes the circuit from the line lead to the station selector's contact springs, corresponding to successive points of contact. The direction of rotation of motor M is controlled by the "plus" and "minus" DX buttons; power to the receiver being shut off when the pointer is in the extreme left position. (Note, however, that transformer T2, consuming practically no current at no-load, is connected to the light line at all times.)

If the screw which holds the pointer to the semi-circular, switch-segment gear shaft is loosened, the pointer will have to be reset; which may be done by placing it so that it points to the insulated gap between the semi-circular switch segments, and then tightening the screw. At this point, the station selector's contact springs do not make electrical connection with the semi-circular segments, and the circuit through the motor field is open.

For 25-cycle operation, it is necessary to change the power transformer, and change 0.1-mf. condenser C14 in the tuned filter circuit to one of 0.45-mf. Of course, it is necessary also to change the phonograph motor in these models.

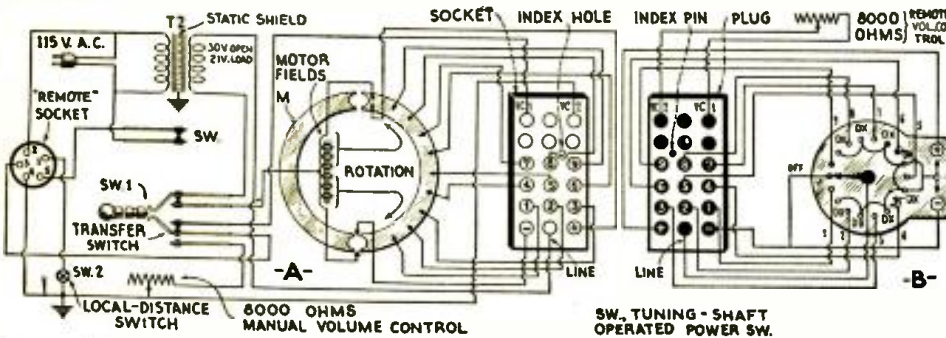

"Model 31" remote-control equipment: A (left), selector unit; B (right), remote control.

In the remote-control model, two 8,000-ohm volume control resistors are available; one in the selector unit, for manual operation, and one in the remote box for control of the volume.

The 15-ohm resistor R1 operates in conjunction with the special local-distance switch found only in the remote-control selector unit.

A 16-conductor cable (two wires unused) connects the selector unit and the remote control. The constants of the receiver chassis components are as follows:

Resistor R1, 15 ohms; R2, 250 ohms; R3, 50,000 ohms; R4, R12, 0.1-meg.; R5, R8, 0.5-meg.; R6, 2,500 ohms; R7, 15,000 ohms; R9, 3,500 ohms; R10, 8,400 ohms; R11, 10,700 ohms; R13, 0.2-meg.

Condensers C1, C2, C3, C4, are the usual tuning units, shunted by trimmers; C5, C8, C12, 0.5-mf.; C6, C7, 0.4-mf.; C9, .001-mf.; C10, C11, .04-mf.; C13, .006-mf.; C14, 0.1-mf.; C15, 0.2-mf.; C, a 3-section 8-mf. electrolytic condenser bank.

Tube average operating characteristics (at 115 volts line potential and volume control at maximum), are as follows: Filament potentials, V1-V5, inclusive, 2.25 volts; V6-V7, 2.35 volts; V8, 4.9 volts. Plate Potentials: V1, V2, V3, 178 volts; V4, 60 volts; V5, 160 volts; V6, V7, 246 volts. Control-grid potentials: V1, V2, V3, 3 volts; V4, 9 volts; V5, 12 volts; V6, V7, 40 volts. Screen-grid potentials: V1, V2, V3, 86 volts. Cathode potentials, V1, V2, V3, 3 volts; V4, 9 volts; V5, 12 volts. Plate currents: V1, V2, V3, 3.4 ma.; V4, 0.25-ma.; V5, 4.5 ma.;

ment. Do not attempt to apply alternating current to this type of condenser, to test its capacity; rather, substitute for a questionable one, a standard of known worth. A crystalline deposit at the vent may indicate that considerable leakage of the electrolyte has taken place; its total loss is indicated as an open circuit.

The tuning control motor M is of the reversible, shaded-pole type and consumes about 20 watts and does not require oiling. Three feed wires control its direction of rotation. A long slender spring, inserted in a slot at one end of the motor, keeps the rotor out of lateral alignment. Therefore, when current traverses the field windings, the rotor is pulled into lateral alignment, engaging the clutch; the reverse operation, upon cessation of the field current, causes the clutch-spring to kick back the rotor, when the semi-circular switch segment stops instantly and the rotor continues to spin freely until it gradually stops. If the motor is not horizontal, gravity will affect the lateral travel of the rotor, in addition to the effects of the above-mentioned spring and the field flux.

Jack-switch Sw.1 moves about 1/8-in. and changes the circuit for manual or remote operation. Switch Sw., also on the back of the gear case, operates, by means of an arm attached to the drive-shaft coupling, to open the power transformer's primary circuit when the drive shaft is in the "off" position.

"Local-Distance" switch Sw.2 is located on the panel of the selector unit; and is operated from the side of the cabinet.

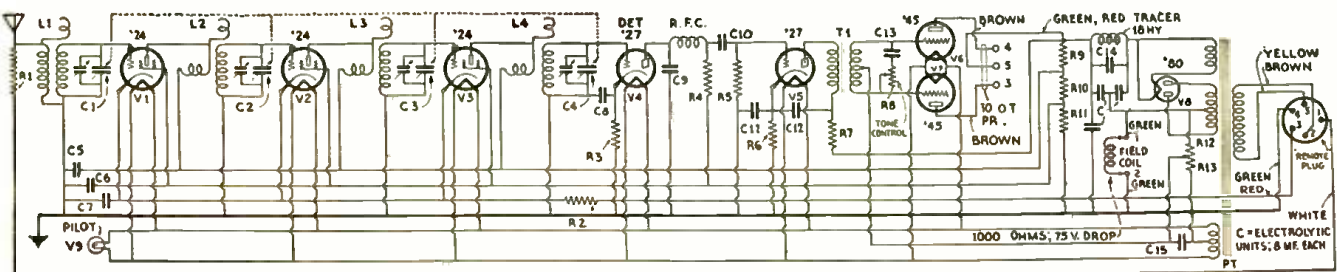

Fundamental circuit of the Apex "Model 31" receiver, wired as the "Model 31-D" remote-control receiver.



PHILCO "TRANSITONE MODEL 3"

Automotive Battery-Operated Receiver with Automatic Volume Control

This model, manufactured by Transitone Automobile Radio Corporation, Philadelphia, Pa., bears no resemblance to previous "Transitone" models described in past issues of RADIO-CRAFT.

Of exceptional interest is the inclusion of automatic volume control; a two-element or diode detector is used. "C" bias is obtained by resistor-drop, as in socket-power sets; as the schematic circuit indicates, there are 20 resistors in this battery-model receiver.

The values of the various components are as follows: resistor R1, 10,000 ohms; R2, R7, R8, R13, 0.1-meg.; R3, R4, R6, 250 ohms; R5, R12, R20, 1. meg.; R9, R10, 30 ohms; R11, R15, 0.25-meg.; R14, volume control; R16, 25,000 ohms; R17, 50,000 ohms; R18, 500 ohms; R19, 309 ohms.

Condensers C1, C2, C3 are the usual tuning units; C4, C5, C6, C9, C10, .05-mf.; C7, C18, 1 mf.; C8, C16, 0.25-mf.; C11, C13, C14, .00025-mf.; C12, .0005-mf.; C15, .015-mf.; C17, 2 mf.

Resistors R6, R9, R10 and R20 are contained in one unit; and resistors R18 and R19 in another. Resistors R3 and R4 are combined with condensers C9 and C10.

It should be obvious that the most important single factor in correct operation of this model receiver, aside from tubes of correct characteristic, is the use of resistors of correct constants. The wattage ratings of the resistors are as follows: R1, R5, R7, R8, R11, R13, R15, 0.5-watt; R2, R12, R16, R17, 1 watt. The resistor color code is as follows: R1, black; R2, R7, R8, R13, silver gray, yellow tip; R5, R12, green, white tip; R11, R15, white; R16, brown, yellow tip; R17, orange; R18-R19, and R20, flat wire-wound.

Tube average operating characteristics are as follows: filament potentials, V1, V2, V3, 2 volts; V4, V5, V6, V7, 5 volts. Plate potentials: V1, V2, V3, 150 volts; V4, zero; V5, 45 volts; V6, 140 volts; V7, 142 volts. Control-grid potentials (negative): V5, 1.0 volt; V6, 2.5 volts; V7, 32 volts. Cathode potentials: V1, V2, V3, 2 volts. Screen-grid potentials: V1, V2, V3, 80 volts. Plate currents: V1, V2, V3, 1.5 ma.; V4, zero; V5, 1.0 ma.; V6, 3 ma.; V7, 16 ma.

If it becomes necessary to re-align the tuned circuits to obtain greater selectivity and volume, use a fiber wrench and adjust the trimmers for a signal between 1,000 and 1,200 kc.; starting first at C3.

Noisy operation may be due to a poor bond between the receiver chassis and the car chassis. A partial test for this possible source of trouble is to remove the antenna leads when noise due to this cause will continue unabated.

Lack of sensitivity, or noisy operation, may be due to close proximity of the antenna in the top of the car to the metal-work; the aerial should be spaced from all such conductors (for instance, the dome light) by a distance of at least 3 inches.

There is only one "A" lead; it is black, and terminates in a lug. Connect this to one of the ammeter terminals on the instrument panel, so that the current drain of the radio set does not show on the meter. The charging rate of the car storage battery should be increased about 2 amps., to compensate for the average amount of current consumed by the radio set.

After servicing an automotive receiver it is important to see that all metal parts—shielding, cable sheaths, etc.—are well grounded to the chassis of the car. Tubes and batteries after replacement must be securely fastened in place.

If it becomes necessary to replace the flexible tuning shaft, the procedure is as follows: push the free end of the flexible shaft through the bracket on the receiver so that the tip of the shaft is seated in the coupler. Tighten the two set-screws on the coupler, and then tighten the set-screw on the bracket just enough to hold the casing in place. Tune in a station of known frequency, adjusting the receiver exactly. Loosen the two set-screws on the coupler which lock the shaft in place. The flexible tuning shaft can then be turned without affecting the setting of the tuning condenser in the receiver. Set the dial scale accurately to the channel number corresponding to the station frequency, and re-tighten the two set screws on the coupler. Check at several points the relation between dial reading and station frequency.

The best material for an aerial is No. 14 or 16 copper screening, 36 in. wide. It should be used to replace all galvanized iron poultry-screen, where the twisted parts are not bonded; cutting and lacing back the latter to make room for the copper screen. Most car tops are of wooden-bow and cloth construction, with perhaps poultry-screen; but, where steel bows are used, instead, greater sensitivity sometimes is obtained by lacing in an antenna of stranded rubber-covered wire.

Poor tone quality may be due to an air space between the reproducer and the baffle (Part No. 2697-A) which should be used with it.

Standard interference suppression includes the use of standard spark-plug series resistors, a distributor (high-tension-lead) series resistor, and interference bypass condensers on the brush side of the generator cutout, and the battery or ammeter side of the ignition coil.

If this procedure (described in detail in past issues of RADIO-CRAFT magazine) does not result in sufficient suppression, it may be necessary to try the following: move the ignition coil from inside of dash to engine side of partition; shield the high- and low-tension leads from the ignition coil to the dash; and securely ground the shielding, or mount the coil on the engine side of the dash. (In some instances the construction of coil and switch may render this impossible; when it will be necessary to use a separate coil and mount it in the engine

compartment). Note particularly that only in rare instances should high-tension leads be shielded; for which purpose "shielded high-tension cable" must not be used.

It may be necessary, in some cases, to connect the "A—" black-with-white lead to the battery instead of the battery-side of the ammeter; and perhaps shield the lead, grounding the shield (copper braid over loom) in several places—a procedure which is particularly efficacious. Improved reception then indicates that further correction should be applied: shielding of the speaker cable, and the battery cable between set and control-unit. All shielding should be grounded. (Commercial shielded-cable is preferable to separate shielding.) In some cases it is desirable to shield the lead from antenna to set; using only "shielded high-tension cable."

Interference due to dome-light coupling may be eliminated by connecting bypass condensers where these wires enter the corner post. Dirty distributor contacts may cause noisy operation; over-wide separation of its contacts may cause the same effect. Reversing the ignition coil's primary leads sometimes reduces interference. Rubbing metal parts of the car chassis occasionally require bonding to the body of the car to reduce cracking sounds; cables, rods and pipes unless grounded may act as ignition-noise carriers. Pay particular attention to the temperature-indicator tube and the oil lines.

Fender, seat, and door pads are available, for use to prevent marring the finish of a car when installing or servicing the radio installation.

Dome-light and switch wiring must be run along the side of the top frame, and along the top edge of the side of a bow to the dome-light fixture.

Lack of signals, or weak signals, may be an indication of a grounded antenna.

All conductors should be well insulated from the car chassis, to prevent short-circuit; while fuses in the "B—" and "A" leads adds a safety factor.

It is suggested that a complaint of poor service from the "B" batteries may be checked by reference to the speedometer's mileage indication for the period of the installation of the batteries. This figure, divided by 25, gives approximately the number of hours the radio set has been used; which, divided by the figure for the elapsed time, in days, since the installation of the batteries, indicates the number of hours per day the radio set has been in use. Heavy-duty "B" blocks should last about 600 operating days (1 hour per day), to 150 days (4 hours per day).

The distributor rotor should just clear all stator contacts (test chalk marks on these contacts should remain undisturbed); file the contacts; or file or peen the rotor, as may be required.

Credit for these data is hereby extended to Messrs. Robert F. Herry and Robert Long, Jr., of the manufacturer's service department.

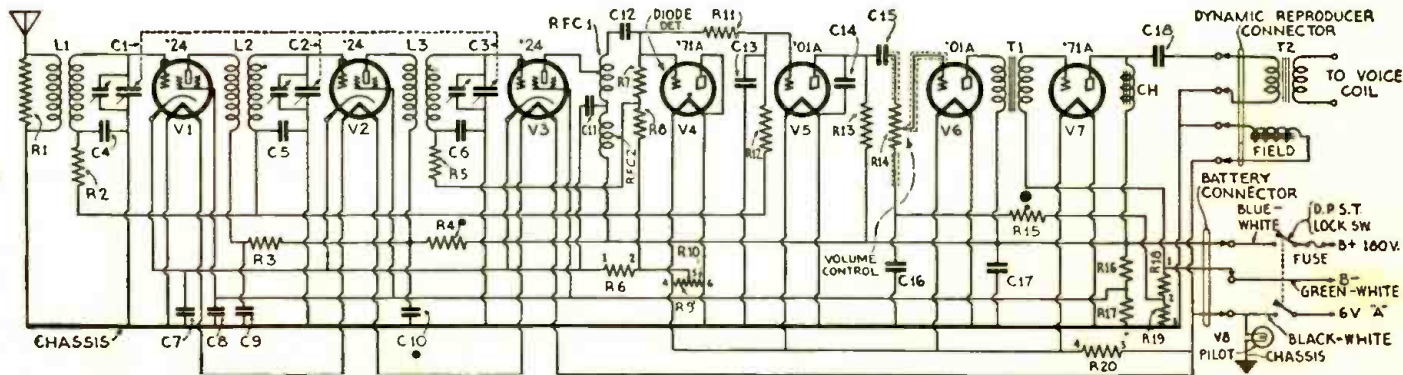

Schematic circuit of the Philco "Transitone Model 3" receiver, incorporating automatic volume control, a necessity in automotive radio sets to overcome the effects of changing location; the total current consumption is 4 amps. The reproducer is catalogued as the "Transitone Model 3 Dynamic Loud Speaker." Resistor R14 is of standard 0.5-meg. rating.



# Leaves from Service Men's Notebooks

*Problems of a more or less unusual nature, and solutions which RADIO-CRAFT'S readers have worked out*

## OLD MODELS—AND BAD TUBES

By J. Paul Miller

**I**N an Atwater Kent early model electric set that is dead, when no plate voltage shows on the detector tube, it is probably due to the phone condenser which is connected from plate to ground; this is either shorted or leaky. Remedy by replacing. The first diagnosis is, naturally, the resistor in the power pack or the primary of the first audio transformer.

In an old model Steinite series-filament receiver, that would not tune above 30 on the dials, the trouble was traced to a short-circuit in the third variable condenser. (This short was in the bearing, and not in the plates touching.) This resulted in the last tube on the chassis being cold. The remedy was to rewind the primary just like the original, and find and correct the short-circuit.

In the Sparton "Model 89A" a baffling problem presented itself in that the volume control was of no effect. The control was not at fault, but a tube was found with a leak between the heater and the cathode. This often happens in new tubes, and a wise Service Man will check very carefully on this item first.

In using a set analyzer remove the tube very carefully, so as not to jar it in any way, and insert in the analyzer; if the tube is jarred the leak may not show up. Perhaps the better way is to remove one tube at a time from the radio-frequency can, and try the volume control with the set analyzer plugged into one of the sockets. When the leaky tube is located the volume control will function; and you will see that the plate current can be controlled from zero to about six or seven ma. (Never have more than one tube out of the circuit at any one time; otherwise a damaged tube may result.)

A Starck old-model electric set would not tune anything with the aerial and ground connected in the proper way. This was found to be due to a short-circuited primary on the first radio-frequency transformer, and remedied by rewinding or replacing the transformer.

Many fading problems may be traced to a cracked filament in a '27 detector tube; watch this tube and you will see it light up and then go out when it gets hot.

Also, fading and weak reception may be traced to the lightning arrestor's being shorted or a broken connection at the terminal. Moral, test this first when a set lacks volume or, especially, if it will not tune on the higher wavelengths.

A resonance hum on push-pull output is not always coming in on the power lines and, often, you will find one of the power push-pull tubes out; this manifests itself by a decided hum when the receiver is tuned to one of the low wavelength stations. See that the tubes are both working.

## REPAIRING SPEAKER CONES

By John J. Nothelfer

**H**AVING bought several speakers with damaged cones (at a good price and with an idea of reselling at a profit), I learned much to my chagrin, the prices for new cones! The prices were so high that a loss instead of a profit would result.

The speakers were damaged at the centering device; this is the case with nearly all damaged cones. I tried repairs, and with good success, after several attempts.

Cutting out the damaged area, I sandpapered the edges of the cut to a rough finish. Cutting a piece of paper from an old cone, I pasted the patch to the damaged area, with white collodion.



Fig. A

Mr. Nothelfer does a little valet work on an old-fashioned paper cone.

It takes a while to dry, and the patch must be held in place all that while, probably an hour. The ordinary hot iron came to the rescue. After raising it to a good, hot "heat," I pressed the iron over the pasted area. In a few minutes the collodion had dried, and it held as firm as if the patches were metal and soldered! To prevent the collodion from getting to the surface of the iron, a piece of paper is laid over the area to be heated.

A new centering device should be installed and the cone replaced on the speaker. The cone is then as good as new, and no fear should be entertained that the pasted patch will come loose.

This idea also works very well with dynamic speakers which have been punctured by accidental means; in this case, ordinary typewriter paper is used.

## THREE SET HINTS

By Helmers J. Huebner

**I**F an Apex "Model 80" gives low volume and a popping noise, see whether the volume control is touching the metal shield. It should be centered and tightened.

When a late 1930 model Apex begins to motorboat, or give harsh tones and incorrect tube readings, it is an indication that the small condensers are out of step. They should be adjusted with the shield in place, by the aid of an output meter.

When an Atwater Kent gets noisy, look for a dirty volume control, in almost any model. The cure is a good cleaning with gasoline.

## MULTIPLE SPEAKERS

By Victor Trad

**A** SIMPLE and economical method of wiring every room for a radio speaker, illustrated here, obviates drilling holes through the ceiling or floor; because one wire may be taken upstairs or downstairs from the outside of the building. I have used the idea quite successfully in making such installations in my neighborhood, and they are working quite well. The arrangement shown lessens losses caused by the use of two wires. (Fig. 2)

A volume control, and a switch also, may

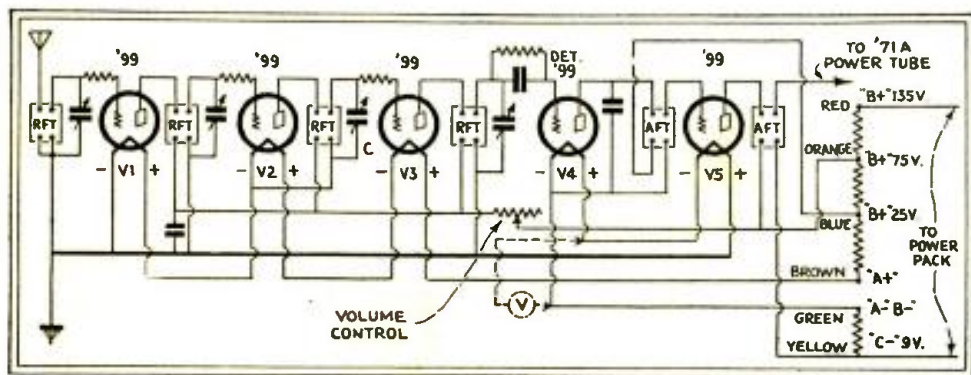

Fig. 1

This diagram of the tuner of an old Steinite model ("991," "992," "993") shows the series-filament arrangement. As Mr. Miller points out, a grounding of the third tuning condenser cuts out the filament of the first tube.



be used in each room, if desired by the set owner; convenience outlets are obtainable, or ordinary electric wall receptacles may be made to serve. The condensers used are of 2-mf. capacity. That attached to the receiver's output is connected to the ground post of the set, when the latter runs directly to the radiator.

(The method shown will be of value to many Service Men who are prepared to add a profitable extra to installation work. It is desirable, perhaps, to add a caution that the use of speakers in parallel reduces the impedance and, thereby, the total effective output of the set to all of them. The new pentode, particularly, requires a large output impedance, as explained elsewhere in this issue. However, if more than two speakers are required, the use of a series-parallel connection will restore the matching of the load to the output tubes. On this subject, it will be of interest to refer to the paragraph "Matching Reproducer Impedance," in the article on page 727 of RADIO-CRAFT for June, 1931; while a very large installation is described therein, the principle is the same.—Editor)

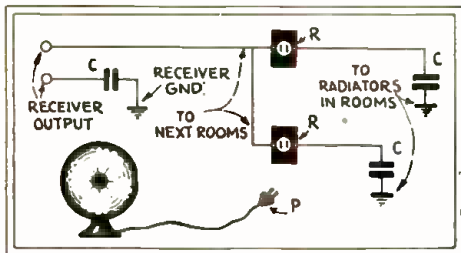

Fig. 2

Mr. Trad finds this method of wiring several speakers to a receiver simple and profitable.

**IRREGULAR BIAS READINGS**

By Frank E. Chambers

HERE was the problem: three '26 R.F. tubes, all biased by a single resistor from filament center-tap to ground, normal filament and plate voltages on all tubes; grid bias on first and second tubes slightly high, none on the third, and plate current on the third three times normal.

Under other circumstances (as with '27 tubes) I would have said immediately—"Biasing bypass condenser shot." But when all are biased by the same resistor—!

A continuity test disclosed an open in the secondary of the third R.F. coil, and on taking off the shield can, a poorly-soldered joint was found. Re-soldering the joint restored everything to normal.

I had never, in five years of service work, struck this particular condition; and this hint may save some fellow a lot of time.

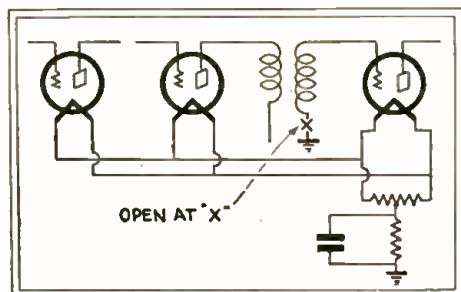

Fig. 3

In an old-fashioned, low-voltage receiver, an isolated grid would block. Note, as Mr. Chambers finds, the tube runs a high plate current.

**BINDING BACK NUMBERS**

By Lawrence M. Faucett

HAVING read every number of RADIO-CRAFT since it began, I have noticed many different suggestions as to filing the information contained in its pages. My way is to list the schematics, and other information which I believe will be of interest; then put the copies together by years, January on the bottom, and drill three holes down through them. I then put machine screws through the holes, and cap them with nuts. Heavy paper covers are used. Blank sheets, on which I have indexed all the information, are placed in front. This makes any particular item easy to find, and does not destroy the magazines. This might help some other reader.

(A binder of a rigid nature, on so thick a book as a year's file of RADIO-CRAFT, is not too convenient to handle. Bookbinders, when they make up a book, saw the back to receive flexible tapes, which permit the back to curve when it is opened; and they remove the staples. As a superior method of filing data, many Service Men find the loose-leaf SERVICE MEN'S HANDBOOK most convenient.—Editor.)

**IMPROVING "R32" AND "RE-45"**

By Joe Williams

THE later or improved model of the Victor "R-32" and "RE-45" is shown in the Official Radio Service Manual. Since there are thousands of the earlier model in use, I think it a good idea to acquaint the independent Service Man with the first hookup; all the changes are in the power pack. (The circuit is also that of the "R-42" and "RE-75.")

If a Service Man comes across one of these old models, he has a chance of making

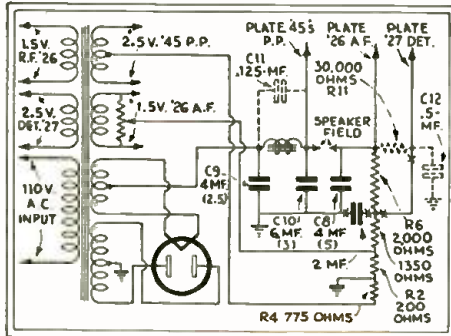

Fig. 4

The changes indicated in dotted lines make an early "R-32" or "RE-45" Victor power pack identical with the standard model.

a little extra money by recommending that the changes be made; for they result in improved reception, less hum and hiss. Only two by-pass condensers and a 30,000-ohm resistor are needed, making the cost low. The condenser block need not be changed; and the job should not take more than twenty or thirty minutes, for it is very easy to get at the "innards of these sets." The changes are shown in dotted lines.

**WANTED, AN UMBRELLA**

By Lynn E. Eddington

RECENTLY I was called to service an Atwater Kent "Model 60" which had developed a loud roaring like that of a beefsteak frying; it was impossible to hear the music. The owner informed me he had sent it to the city to be serviced, and after

its return, it had played very nicely for one night; then the noise came back as loud as ever.

He pulled out one of the '45 power tubes and the noise stopped. Of course there was a reduction in the volume, but he said they had used it that way for about three months. Also, I was told, water had run out of the aluminum can next the aerial and ground posts, and fire also had shot out of it. But, since this receiver has no electrolytic condensers, I knew the water must have come from an external source. I examined the lead-ins, both aerial and ground, which ran through the wall, about three feet above the set. Streaks of dirt on the aerial lead-in showed that rain water had run down it, into the receiver. However, the water had done no permanent damage to the receiver and, when it had dried out, it worked as well as ever. I changed the lead-ins and there has been no more trouble. This is the first time in seven years I have encountered a condition of this kind.

(The National Electric Code, commonly described as "Underwriters' Rules," specifies that "Each lead-in conductor shall enter the building through a non-combustible, non-absorptive insulating bushing, slanting upward toward the inside, or by means of an approved device designed to give adequate insulation and protection." The reasons are obvious; and violations of the rule should be encountered even less frequently. Incidentally, why did pulling out one power tube relieve the noise, unless the set had been affected beyond the earlier stages?—Service Editor.)

**A LIGHT BLOW TORCH**

By J. E. Kitchin

PROBABLY some of you Service Men with the ever-handy power lines have never had to solder without a soldering iron. The following, however, may interest those who, like myself, are sometimes in a district where power is not available.

Procure an atomizer, of the type used for perfuming, or for spraying the interior of the mouth and nose. Remove the cork, to which are attached the rubber and metal tubes. Cut off the stem, which dips down into the bottle in regular use, and plug this tight with stopper S. Cut the bulb off the rubber tube and, if there is a spray nozzle at the end of the metal tube, remove this. You now have a blowpipe which will direct a flame with needle-like sharpness. Carry this, with a short length of candle, in your kit. When you need to use it, simply take

(Continued on page 174)

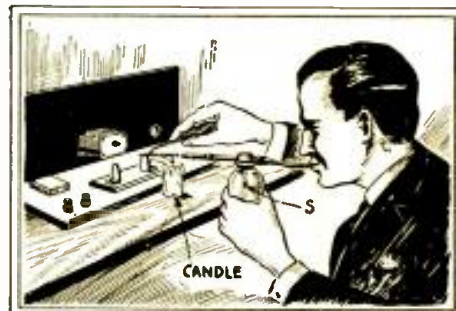

Fig. 5

Blowpipes are obtainable from laboratory supply houses; but Mr. Kitchin takes this ingenious way to make one of light weight. (The bottle need not be retained as a handle!)



# The Service Man's Open Forum

*His Opinions on Conditions and Practices in the Radio Business*

## ATTENTION TO DETAIL

*Editor, RADIO-CRAFT:*

For the past seven years, I have been in the service field, and at present I am service manager for the Lewis Electric Co. We have no room for a "flying Service Man;" anyone who has been in the game very long knows that to learn the condition of the entire set by plugging an analyzer into one socket, is an impossibility.

We have a thriving business, and it can be attributed to good service. When it is necessary to bring a set to the shop for repair, I always see that all tube contacts are cleaned and made firm and that the volume control is cleaned; this takes only a short time. We always check each and every tube and keep a record which will be useful. We also find it advisable to check the antenna and ground on each call.

Another thing, so often neglected by Service Men, is the cleaning and dusting of the chassis and its various units when it is brought to the shop. We always dust them off, clean the dials and make sure that the dial lamp is the right size and that it is tight in its socket. Of course, one wouldn't go into a patron's home and proceed to make the dust fly without asking permission of the owner; and this must be done diplomatically, for some people will not like it if you even hint that the set is dirty.

We do not believe in wasting time; but it is not wise to rush into a house, make the needed repair, and rush out again. It often happens that someone will call in and want a burnt-out tube replaced; and a Service Man dashes out with a new tube and places it in the set without checking the voltage to see what caused the burn-out. Recently, we encountered a case in an RCA "17;" one after another, '71A tubes had been put in the set and burned out after a few days. The last time, I answered the call and found 7 volts on the filaments; there was a line voltage of 120, while the adjustment was set for low voltage. The other Service Man lost a customer, and we gained one.

We certainly appreciate new customers,

but we take special care to keep the good will of our old standbys, some of them four-year-old accounts. We find that watching the little things that cause back calls keeps the public's good will.

Let's hear from some of you analyzer-toting guys. Do you agree with me?

CARL J. FINGER,  
Bedford, Indiana.

## SETS THAT NEVER GO WRONG

*Editor, RADIO-CRAFT:*

Some time ago I serviced an Atwater Kent receiver, in which the trouble was due to a shorted filter condenser. I went to the A.K. distributor and purchased a new condenser, and asked the man if he knew the capacity. Yes, he knew the capacity; but he could not tell me, because his company did not allow him to do so, and if I wanted to know, I would have to find out for myself. "I don't see why you need that condenser," he furthermore observed: "Our sets are foolproof and never go wrong." (Dial that on your superhet!) Anyhow, I swallowed that along with the rest.

A few days later another Atwater Kent "never went wrong"; this time a volume control was burnt out. So I went to the same place for a replacement, and a different man came to my rescue this time. I asked him if he would be kind enough to tell me the resistance of the volume control; and he regretfully informed me that Mr. Atwater Kent did not allow his distributors to give any information about his receivers, to anyone not directly connected with the company.

Well, fellow Service Men, here is the opinion I have formed. I am the proud owner of a copy of the *Official Radio Service Manual*, and I have noticed that all Atwater Kent circuits are furnished without any data in regards to part values. This surely goes to show that Mr. Atwater Kent does not care to help the independent Service Man. (I notice that a few other

*(Continued on page 178)*

## AN IMPORTED HINT FOR THE RADIO INDUSTRY

IN the pages of *Wireless World* (London) a few days ago appeared a letter from a technician who had in mind a public service. Mr. Balbi, who is electrical advisor to the National Institute for the Deaf, makes a suggestion to the British radio trade which, with the substitution of a few more familiar terms for an American reader, is as follows: comment seems unnecessary.

"About every tenth person in this country above the age of thirty has defective vision, but when such a fate overtakes any one of us we do not despair; we set out to find an optician from whom to buy a pair of spectacles. Our search will not necessarily resolve itself to a visit to some city; for in practically every trade centre a qualified optician will be found who is ready to sell us a pair of scientifically-prescribed lenses, mounted in what kind of frame our fancy dictates, for about \$5.00. However, let us suppose that a monopoly of spectacles was in the hands of three or four London firms who at best had a few branches in other cities; and, moreover, that instead of the price being about \$5.00, it was about \$50.00.

"In these circumstances there is no doubt that decidedly fewer people would be wearing glasses; and, even if the price were allowed to remain the same, I firmly believe that a great number of people would be deterred from buying merely because of the inconvenience of having to go so far for what they were seeking.

"This, however, is how the state of affairs stands at the present moment in regard to *electrical hearing appliances for the deaf*. If one could realize the harm that would be done to the country if a million or so of its inhabitants were suddenly robbed of their spectacles, one could also gauge the benefit that would be derived in having an efficient service for the distribution of electrical appliances for the deaf throughout the country.

"Who is in the position to undertake this great work? Why, surely, the radio dealer. Ten years ago he was not. Five years ago he could not; but to-day his technique has developed to the necessary extent of being able to handle any article involving the reproducing of sound. If the dealer has been established some years, he will already have the confidence of a large number of his customers, many of whom may be in need of an acoustical instrument.

"A great boost would be given to our radio manufacturers if they would turn their attention to this new field of industry. The price of a fifty-dollar 'deaf aid' would quickly tumble when manufactured on a mass-production basis, and would probably result in a better article being available. What person faced with the necessity of buying such an appliance would not prefer to buy it from his local dealer for \$5.00, rather than to be obliged to go to some firm that is charging him \$50.00 for probably an imported inferior article?

"My opinion is that, as in the case of radio, it needs but a spark to set this new industry ablaze.

"CHARLES M. R. BALBI,  
A.C.G.I., A.M.I.F.E."

WE called to-day as requested to service your Radio. Please call our Service Dept. Crescent 5983 and make a definite appointment. .: .: .: .: .:

## OVERCOMING THE "NOBODY HOME" TROUBLE

By F. J. Siefke

When the Service Man of a Buffalo, N. Y., radio dealer calls in response to a request and finds no one at home, he leaves one of the cards reproduced at the left. This shows the customer the dealer is on the job, and saves fruitless back calls for the Service Man.



# How to Test the Pentodes

*Methods of adapting standard analyzers and tube checkers to the new tubes*

By F. L. SPRAYBERRY

**T**HE advent of the "Pentode" tube has made most testing equipment obsolete; only one model set analyzer incorporates facilities for testing pentode circuits without adapters or wiring changes. However, any set analyzer or tube tester may be brought up to date by the use of adapters or by making circuit changes.

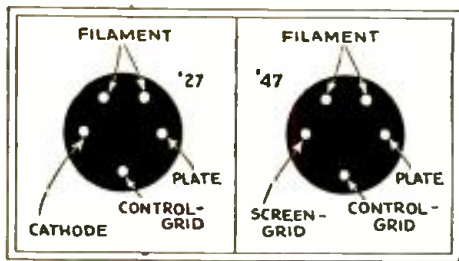

**Fig. 1** **Fig. 2**  
The arrangement of the UY base of the '27 is shown at the left; connections to '47 and '33 bases at the right.

Since various models are wired differently, a different adapter is required for each type of tester; although all circuits can be arranged to test the pentode tube by making the same wiring changes if permanent connections are wanted.

The reason adapters or wiring changes are necessary to test pentode circuits is that the elements of the tube are connected to the tube-base prongs in a way differing from standard practice. Fig. 1 shows the connections of a '27-type tube to its five-prong or UY tube base; proper identification is made when the prongs of the tube are pointing towards you. Fig. 2 shows the arrangement of the tube prongs on a '47 pentode's base, also with prongs pointing towards you.

Notice that the "K" or cathode prong now becomes the screen-grid prong; while the control-grid connection continues as such. From the former fact, you can see that the regular tester circuit does not include meter ranges, connected properly to the grid and cathode circuits, to test voltages applied to these circuits of a pentode tube. (For characteristics of the pentode tube, see page 161 of this issue.)

A meter range of at least 250 volts is required for the screen-grid circuit, and one of at least 17 to 20 volts for the control-

grid circuit. At times it is desirable to measure the screen-grid current; and connections must be provided to connect the milliammeter of the test instrument in series with the screen-grid circuit. (The cathode grid is connected internally to the heater or filament circuit, and therefore no measurements are required for it.)

### Testing Pentodes

In order to test pentodes on the Jewell "209" and "210" tube checkers, a five-hole four-prong adapter is required, Fig. 3. This is commercially available as Na-Ald "Type 954 KPC." Insert the adapter into the four-prong socket on the tester, and place the pentode in the adapter. The "emission current" can now be read on the milliammeter of the tester. This adapter ties the screen-grid to the plate when testing the pentode.

At the time of this writing, the normal values of the pentodes announced by the different tube manufacturers were not available to the writer; but it is suggested that a good pentode tube, known to be in good working order, be tested and the value obtained will serve as a standard when testing a tube of doubtful condition. (See page 163.)

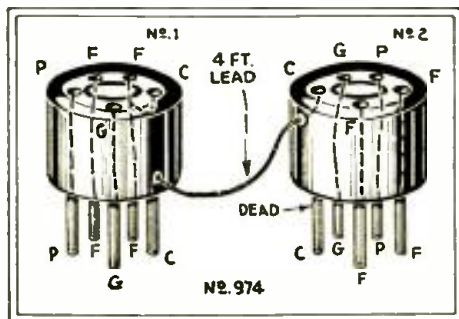

**Fig. 4**  
The twin-adapters shown, used with any Jewell analyzer, makes screen-grid voltage measurements with the aid of the external test leads.

The "954KPC" adapter can be used also in conjunction with the "Dayrad" and "Sterling" tube testers; all that is necessary is to insert the adapter into the regular four-prong socket, and insert the tube in the adapter. Set the filament voltage at 2.5. Emission current will now be indicated on the tester meter.

In order to test pentode tube circuits with the Jewell analyzers, it is necessary to use a twin adapter, (Fig. 4) available as Na-Ald "Type 974." These two adapters are connected together by means of a single four-foot lead of insulated wire between the cathode prong of adapter No. 1 and the cathode receptacle of adapter No. 2.

Because of the internal connection of the Jewell analyzers, no screen-grid measurements can be made with this set of adapters. This does not prevent the measurement from being made, however; for the screen-grid voltage can be measured by means of the external binding posts of

the analyzer. Be sure to use the proper voltage scale for the screen-grid; the usual applied potential is 250 volts.

When making the screen-grid voltage test, remove the test plug from the set socket. Place one test lead in the so-called cathode receptacle of a five-prong socket, and the other test lead in the adjacent heater receptacle. The plate and screen-grid circuits will have the same value of voltage; and, as these terminals are opposite on a five-prong socket, make sure you have connected to the screen-grid receptacle of the socket. All other measurements are made in the usual way, using the twin adapters, of course. The above connections apply to any Jewell analyzer, which includes facilities for testing the 22 and 24 type screen-grid tubes.

To test pentode tube circuits with the Weston "547," "565" and "566" set testers, the Na-Ald "Type 945GL" and "954GL" adapters are required (See Figs. 5 and 6). The "954GL" is inserted in the UX socket of the tester, and the lead brought out from the grid receptacle of the adapter connected to the grid terminal, on the side of the test panel of the tester.

The "945GL" four-hole five-prong adapter is attached to the test plug, and the lead brought out from the grid prong is attached to the grid terminal, on the side of the test plug.

The test plug is now inserted in the tube socket, and the tube is placed in the socket on the test panel. The positions for the rotary switches on the testers are as follows:

### Model of Tester

Pentode ....	"547"	"565"	"566"
Plate voltage	B-250	B-250	B-250
Sq. voltage.	C-250+	Sq-250	C-250
Control			
grid V....	Off scale	Contr. G-100	Contr. G-100
Filament V.	AC4	AC4	AC4
Plate current	Toggle Sw. 100	Toggle Sw. 100	PL. MA. 100
Sq. current..	Rect. 100	SG-25	SG-25

When testing the pentode tube on the "533" or "555" tube checker, or the "565" used as a tube checker, place a Na-Ald adapter "Type 975," (Fig. 7) in the UY socket, and the tube in the adapter. Set the filament voltage at 2.5. Use the high range of the milliammeter but read on the 0-20 scale.

(Continued on page 163)

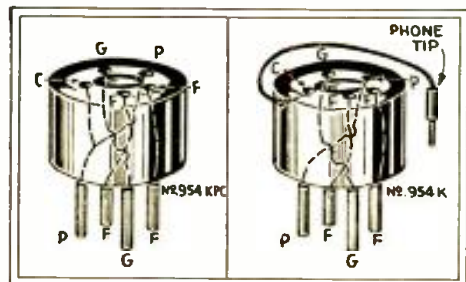

**Fig. 3** **Fig. 9**  
Left, adapter for direct readings with Jewell tube checkers; right, adapter for Sterling set testers.

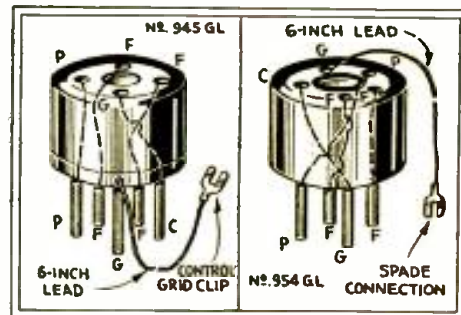

**Fig. 5** **Fig. 6**  
The pair of adapters shown are required for pentode measurements on Weston set testers.



# The A. C.

Developed by

A two-tube electric set,  
is especially adapted to

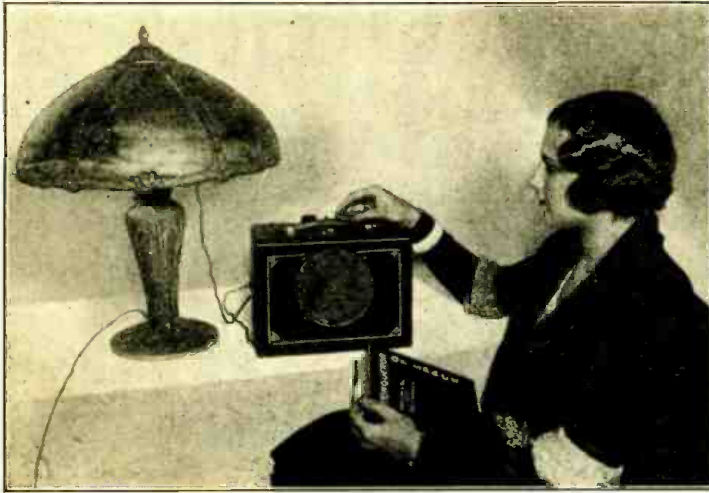

The appearance of the RADIO-CRAFT A. C. Pentode Portable is neat; it is easily operated.

**I**N the previous issue of this magazine, the constructional details of the "Radio-Craft Pentode Portable" appeared (Page 88, August, 1931); this receiver, with but two tubes and light, self-contained batteries and speaker, gives a moderate loud speaker output. Here we present the promised instructions for building a two-tube portable, of similar size, but designed for operation from the 110-volt A.C. light socket, and giving volume sufficient for the largest room. As shown in the schematic diagram (Fig. 1), a dynamic reproducer of special light-weight design and a high-voltage supply, supplying rectified current through a standard '80 tube, make possible an output unapproachable with a similar weight devoted to batteries.

While some may argue that a true portable receiver should be battery-operated, and so serviceable under all conditions, we believe that there are very good reasons for featuring a portable electric receiver, and that many will find superior features in such a set. It is true that the electric set cannot be operated in outlying districts, where alternating current is not available; but its merits more than outweigh this disadvantage, especially for the many who pass their vacations in summer hotels, or popular resorts, or who do a lot of traveling.

### Advantages of the Electric Portable

With an A.C. circuit, high operating voltages are available with a minimum of weight. The power tube can be operated at its normal plate voltage; so that much greater

output is available than could possibly be obtained with a reasonable load of batteries. Not only does the higher plate voltage allow for greater power output, but tone quality is also improved thereby. The use of a dynamic speaker further adds to the tone quality. And, last but not least, the set is always ready for operation; there are no batteries to run down or replace.

Summing up, the electric set is much lighter in weight than a battery set, for equal power output; and considerably less expensive to operate. The set illustrated herewith measures 6½ x 11 x 8½ inches (outside dimensions) and weighs only 12 pounds. On local stations, by direct comparison with a modern, commercial six-tube superheterodyne receiver, this set actually gives greater volume than the superheterodyne. The superheterodyne, of course, is more selective; this being the only point in which it excelled the two-tube portable.

The circuit (Fig. 1) consists essentially of a regenerative screen-grid detector, using a type '24 tube, coupled to a type '47 pentode. A type '80 rectifier, delivering D.C. plate voltages, is operated from the power transformer; the latter also furnishing alternating filament current for the two receiving tubes and the rectifier.

A midget-type dynamic loud speaker, with its field coil serving as the only filter choke in the power supply circuit, is connected to the output of the pentode.

An A.F. transformer secondary, in parallel with a 250,000-ohm resistor, is employed

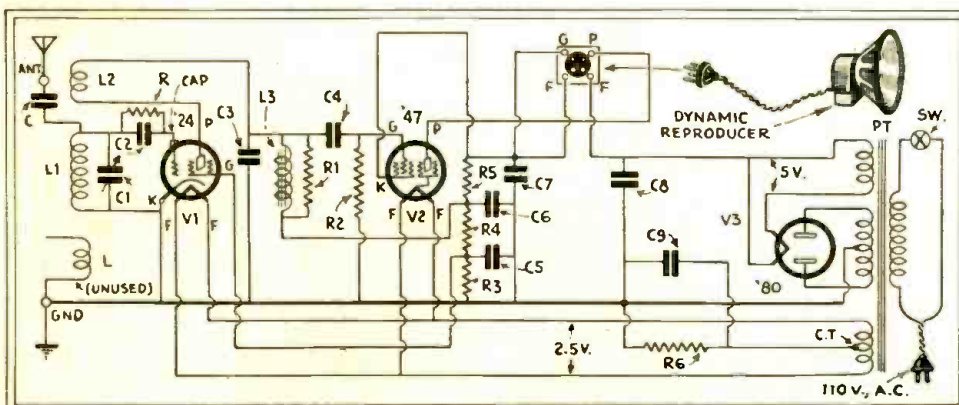

Fig. 1

The circuit adopted in the model illustrated here; several connections for the detector are shown elsewhere. The volume control is furnished by the rotating tickler; the tuning dial C1 is the only other control.

### ASTONISHING VOLUME

**T**HAT a single screen-grid tube, in conjunction with a Pentode, can operate a dynamic loud speaker, will at first seem improbable. That such a combination actually out-performs, in point of volume, a modern five- or six-tube midget set, will probably tax your credulity; but, nevertheless, these are the facts.

The present combination, which we believe has not been used before, is really remarkable for the results that can be accomplished. Some of the New York locals came in with such power that this little, insignificant set filled a ten-room apartment with music that could be heard loud and distinct; and when it was turned on full, it was impossible for two people to converse with each other in the same room.

We warmly recommend this combination to radio experimenters and builders.

as a coupling unit between the detector and the pentode. The use of the choke is preferable to straight resistance coupling; because the latter reduces the detector plate voltage to a serious degree. The choke, on the contrary, does not cause a great voltage drop; and by shunting it with the resistance the frequency characteristic is improved. In other words, the load impedance on the detector can never exceed the value of the resistance; whereas, with the choke alone, the impedance would be considerably higher at resonance than at other frequencies, and distortion would result. The resistance flattens the characteristic curve, thus improving the tone quality.

### Optional Regenerative Circuits

By studying the diagram, it will be found that the circuit design is conventional, so far as the power supply and audio frequency connections are concerned. The methods of tuning, and of controlling regeneration, however, are of sufficient importance to be described separately. Under actual tests, the radio-frequency circuit was found very critical. It therefore offers a field for much further research. Formerly, with three-electrode tubes, a simple regenerative circuit with tickler-feedback functioned very well. Such a circuit, used



# Pentode Portable

the RADIO-CRAFT Laboratories

light in weight, compact, and attractive in appearance, which the needs of the tourist and gives astonishing volume.

with a screen-grid tube, is illustrated in Fig. 2. With the type '24 tube, many circuit combinations are possible. For this reason, we are showing several optional connections; so that the builder may experiment and select the circuit which proves the best for his particular conditions.

The circuit of Fig. 2 worked fairly well in this set. The volume on local stations was very high. Distant stations could not be tuned in very well on the loud speaker; but the selectivity was good and the circuit does not radiate much energy from the aerial to annoy the neighbors. A 100-foot aerial, used in making these tests, consisted of a single wire dropped out of a 12th story window.

On changing the aerial connection to that of Fig. 3, locals just roared in. It was amazing to listen to the enormous increase in volume with the screen-grid detector connected in this manner. This circuit has the disadvantage, however, of radiating considerable energy and causing interference; but, if it is intelligently operated, there is no need of producing a disturbance in the ether. If the receiver is used in sparsely settled districts (which is likely on vacation trips), the problem of interference with neighboring sets is eliminated.

It may be well to supply two or more aerial binding-post connections on the set, to suit various conditions. Fig. 4 shows an ideal method using a tapped coil.

A simple three-circuit regenerative tuner was employed in making these tests. By leaving the tickler fixed, and controlling the screen voltage, as in Fig. 5, a smoother control of regeneration is possible. This method of control may be employed with any of the other circuits shown, in which case the tickler and tuning windings may be placed on the same insulating tube.

The tuning circuit of Fig. 3 was selected for the model adopted, as shown in the

main diagram (Fig. 1) and is used in the set shown in the various illustrations.

### Construction of the Set

No great pains were taken in building the set. First, a suitable carrying case was selected; this may be homemade, following the dimensions of Fig. 6. Then the parts were placed wherever they would most conveniently fit; securely fastened to a wooden base board with screws; and then inserted in the case. The small dynamic speaker is mounted on the cover, as shown. The parts within the box must be arranged so that, with the cover closed, the speaker will not interfere. It is not necessary to use the identical size of case given in the list of parts; any other case large enough to accommodate all component parts in a compact arrangement will do.

The tuning condenser knob, regeneration control and line switch are mounted on the

top of the case (when closed) near the carrying handle; so that the set may be operated with the cover closed. Ventilating holes should be cut in the case; because the tubes and resistors become quite hot and require air circulation. The aerial and ground wires and light-line cord pass through slots in the side of the case when in use; they can be rolled up and placed inside when not in use.

By mounting the parts on a wooden board, the wiring is made much easier. The set is readily wired by following the schematic diagram.

The values of all of the parts are given in the list; following from this, select components of the same type or of similar rating; and then proceed to mount them on the base board in the general arrangement shown in the reproduced photograph. The parts on the board may be completely wired.

(Continued on page 175)

At the right, the appearance of the A. C. Pentode Portable when opened. The case is a little deeper than that of the battery model described last month; to accommodate the dynamic speaker; but its weight is the same. All external connections may be withdrawn into the case.

Below, optional connections; Fig. 3 gives a stronger signal, although it radiates more. Fig. 4 gives better results, with an added adjustment; Fig. 5 is an excellent regeneration control with a fixed tickler, on a 45-volt tap.

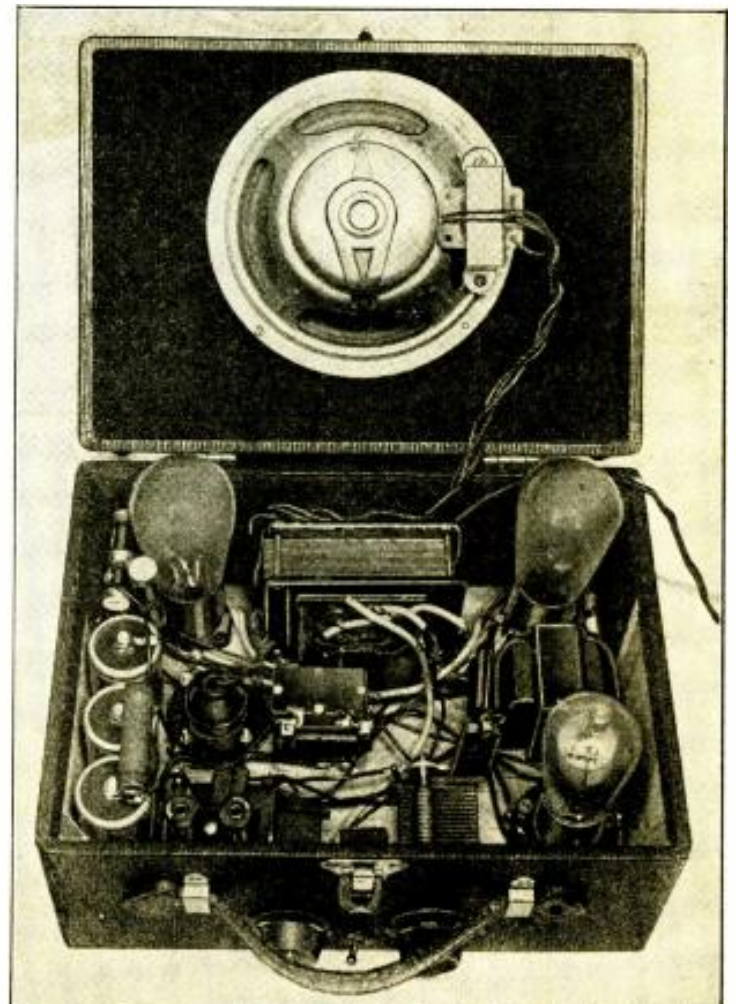
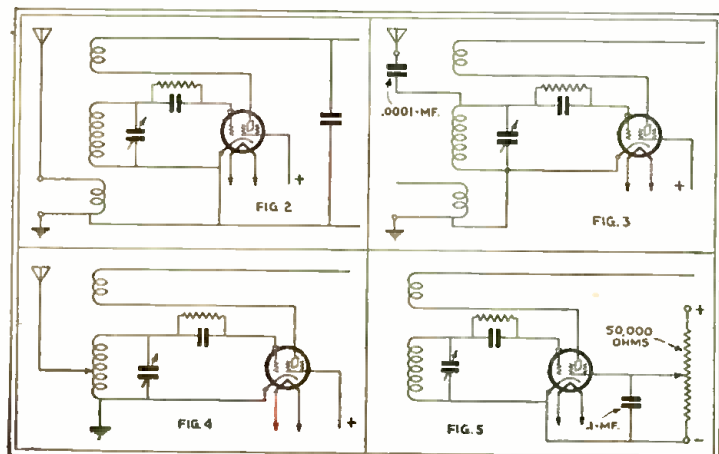



# Up and Down the Waves with the Scott "All-Wave" Superheterodyne

*An Evening with "DX" stations on the Long Waves  
and A Morning with Foreigners on the Short Waves*

By MARCELLUS H. GERNSBACK

**H**AVING heard many favorable reports about the new Scott all-wave superheterodyne receiver, the writer was delighted at the opportunity to take one of these powerful 12-tube sets to his home for a thorough reception test.

The appearance of the chassis made a hit with the feminine members of the family at first sight; and some of my friends were so taken up with its appearance that they insisted on calling it the "cocktail-shaker receiver"!

The location is in the heart of upper New York City, a place notorious for man-made electric interference, and not the best reception spot that could be desired. Nevertheless, when the set

*"The cocktail-shaker" chassis was so described because of its modernistic, all-chromium finish. It is, however, designed for all the demands of an exacting set owner—including microphone and phonograph pick-up, as well as recording, accomplished with the aid of the control box in the foreground.*

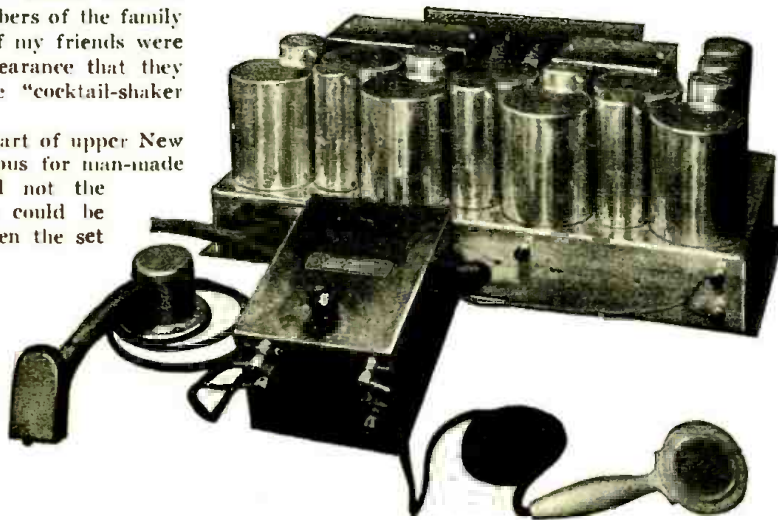

was turned on, interference was found to be much less than had been expected; a result due to the high selectivity of the receiver and intermediate frequency amplifiers' tuning circuits, no doubt.

The first test was for tone quality on local stations. The set came through this with flying colors; for the quality was remarkably fine, from the bass register way up to the treble range. The quality, moreover, was practically unaffected by the set-

ting of the volume control; either soft or loud reception was excellent.

While testing the receiver on local stations, it was found that the kilocycle calibration of the two tuning dials is very

## Long-Wave Broadcast stations heard with the Scott All-Wave Superheterodyne

### Before midnight

WBZ—Springfield, Mass.  
KDKA—Pittsburgh, Pa.  
WHAS—Louisville, Ky.  
WGY—Schenectady, N. Y.  
WBBM—Chicago, Ill.  
WJR—Detroit, Mich.  
CKAC—Montreal, Canada  
WLW—Cincinnati, Ohio  
CKGW—Toronto, Canada  
WPTF—Raleigh, N. C.  
WDBJ—Roanoke, Va.  
WIP—Philadelphia, Pa.  
WICC—Bridgeport, Conn.  
WLIT—Philadelphia, Pa.  
WFBL—Syracuse, N. Y.  
WJAS—Pittsburgh, Pa.

### After Midnight

WBT—Charlotte, N. C.  
WHO—Des Moines, Ia.  
WENR—Chicago, Ill.

WFAA—Dallas, Tex.  
WRC—Washington, D. C.  
WFIW—Hopkinsville, Ky.  
WTAM—Cleveland, Ohio  
WTIC—Hartford, Conn.  
KYW—Chicago, Ill.  
WOC—Davenport, Ia.  
WGN—Chicago, Ill.  
WBEN—Buffalo, N. Y.  
WAPI—Birmingham, Ala.  
Two Mexican stations, one on 910 kc.; the other about 740 kc.  
KRLD—Dallas, Tex.

### Daytime. (10 A.M.-5 P.M.)

WIP—Philadelphia, Pa.  
WLIT—Philadelphia, Pa.  
WICC—Bridgeport, Conn.  
WGY—Schenectady, N. Y.  
WTIC—Hartford, Conn.  
WPG—Atlantic City, N. J.  
WRVA—Richmond, Va.

## SHORT WAVE STATIONS HEARD

with the Scott All-Wave  
Superheterodyne

16.36 WND—Lawrenceville, N. J.  
16.38 GBS—Rugby, England  
And other transoceanic phones,  
"scrambled")  
16.82 PCV—Kootwijk, Holland  
25.24 W8XK—Pittsburgh, Pa.  
25.42 I2RO—Rome, Italy  
25.53 G5SW—Chelmsford, Eng.  
25.63 FYA—Pontoise, France  
31.38 ... Zeesen (Konigswuster-  
hausen), Germany  
48.80 VE9CL—Winnipeg, Canada  
48.86 W8XK—Pittsburgh, Pa.  
49.02 W2XE—New York City  
49.18 W3XAL—Bound Brook,  
N. J.  
49.50 W8XAL—Cincinnati, Ohio  
49.83 W8XF—Chicago, Illinois  
84.50 up—Amateur phone stations

accurate over the broadcast band.

## Distance Work on Longer Waves

When this was thoroughly checked, the writer decided to go fishing for some out-of-town stations, though without expecting much success, since it was then only 9 P.M. (daylight saving time) and the date was June 29—only a week after the longest day in the year. One must admit that these are unfavorable conditions for distant reception on the broadcast band; especially in New York City, with about thirty local stations on the air.

I was in for a surprise, however; for I was able to pick up a large number of out-of-town stations with good loud-speaker strength. (See station list.) These transmissions came in, not only loud and clear, but also with no trace of interference; even when the distant station happened to be adjacent to the channel of a powerful local. The receiver was obviously as selective as any set need be. This super-selectivity did not, however interfere with the receiver's audible-frequency response; as so often is the case in a highly-selective tuner, which cuts the sidebands.

One of the most difficult tests in New York City is to separate WOR, on 710 kc., from WLW on 700 kc. An outfit which can do this has "got the goods," as the saying goes. With the Scott receiver this feat was very easy to perform; WLW could be tuned in with no troublesome interference from WOR.

During this early-evening session, about 35 out-of-towners were pulled in. One pleasing feature of this performance was that all these stations came with the same strength and quality as the local transmitters.

After I had satisfied my curiosity on these points of selectivity, quality and sensitivity, I decided to sit back and enjoy one of the local programs for a time. This was  
(Continued on page 178)



# A Short-Wave Converter for D. C. Light-Lines

*Especially Suited for D.C. Broadcast Receivers*

By W. E. SMITH

**W**ITHOUT doubt, the superheterodyne system of receiving short waves presents fewer difficult problems than any other. While it is possible to construct a complete short-wave super, the writer believes it preferable, for the large number of broadcast listeners, to supply adapters which they can use with their present receiver.

Many of the adapters put on the market are hard to operate. Some must be plugged into the set and, in many cases, are failures; because of not any fault in the design of the adapter, but failure to get the proper voltages, etc. On the other hand, how many broadcast listeners today know which is the detector socket? And, if the set owner found the right place to plug in the adapter, he couldn't do so on account of the shielding.

The adapter here described is powered from a 110-volt D. C. light-line and, when connected to any receiver, converts it into a powerful short-wave superheterodyne. With the switching system shown in the diagram (Fig. 1), it is very easy to receive either short- or long-wave broadcasting at will.

The converter contains a '36-type first detector V1 and a '37-type oscillator tube V2. The amplifier V3, which works at a broadcast radio frequency, and provides the input to the broadcast set used with the converter, is also a '37. These tubes, which have been described in recent issues of *RADIO-CRAFT*, are all of the indirectly-heated cathode type, taking 300 milliamperes on the filament at 6.3 volts; and therefore are specially well adapted to operation from a D. C. line.

The three heaters are connected in series, the voltage drop across which will be 18.9 volts. Assuming the line voltage is 110, there will be a difference of 91.1 volts which must be dropped. At 300 mills., this requires 303.7 ohms resistance; since this is not a standard size, we can use a 300-ohm fixed resistor, of 30 watts rating or more, at R5; with a 10-ohm rheostat in series.

The other voltages for the tubes are obtained, through the choke coil, directly to the plates of the modulator tube V1 and the R.F. tube V3.

The plate of the oscillator tube V2, and the screen grids are fed through the resistor R6; and R4 takes care of excess plate current.

This adapter can also be used on 32-volt lighting systems. Substitute a forty-ohm resistor at R5; leave out the 30-henry choke and condensers C10 and C11. Then connect in "B" batteries as indicated.

### Design of Coils

It will be noted that the detector's tuned input L1 and the oscillator coils L2-L3 are inductively coupled, being wound on the same form. The specifications for the plug-in coils used are as follows:

	Coil 1	Coil 2
	Turns	Turns
L2	25	10
L1	25	10
L3	15	7

They are wound with No. 28 S.S.C. wire on forms 1 1/4 inches in diameter, and 2 1/2 inches long.

**F**OR the owner of a D. C. electric receiver, this super converter will be especially convenient, since it works from the light line, with the new 6-volt tubes. Converters hitherto available have been either A. C. or battery operated.

The unit described may be operated also from a 32-volt domestic lighting plant; but in that case, it will be necessary to supply the plate and screen-grid voltage from batteries, though the use of the "A" storage battery is obviated. The owner of the latter, however, might also use this excellent and sensitive circuit, by wiring the tube heaters in parallel instead of in series.

Coil L4 is an ordinary shielded radio-frequency transformer for screen-grid tubes, as used on the broadcast band. For a 1-inch form 2 1/2 inches long, wind 95 turns of No. 30 enamelled wire, with a layer of insulation over the filament end of coil. Over this, wind 50 turns of 35 or 36 enamelled wire. The 95-turn winding is tuned by a small semivariable condenser C3, about .0001-mf., to the lowest setting of the broadcast receiver—around 1500 kc.

It may be, however, desirable to tune L4 to a higher wavelength, in cases where the

receiver is not sensitive or will not tune below the broadcast band. It is best to pick out a frequency where no station will come in at any time; in my location I use either 1485 or 545 kc. But, if you choose 545 kc, you will have to use a small .0005-mf. adjustable capacity for C3.

### List of Parts

- Two Pilot "No. J23" .0001-mf. variable condensers, C1-C2;
- One Pilot "No. VM81" 45-500-mmf. adjustable condenser, C3;
- One Pilot 3-section (0.2-mf.) non-inductive bypass condenser, C4-C5-C9;
- One Pilot 2-section (0.2-mf.) non-inductive bypass condenser, C6-C8.
- One fixed condenser, .001-mf., C7;
- Two Pilot "No. 9302" 300-volt, 2-mf. fixed condensers, C10-C11;
- One series antenna condenser, .00025-mf., C;
- One Pilot 30-henry choke;
- One broadcast R. F. choke, 60 millihenries or more, RFC;
- One *Electrad* "Type C3" 300-ohm "True-volt" resistor, R5;
- One 10-ohm rheostat, R7;
- Five *International* fixed resistors; 2,000-ohm, R3; 10,000-ohm, R6; 7,000-ohm, R4; 500-ohm, R1; 300-ohm, R2;
- Three binding posts, BP1-2-3;
- Four UY sockets, one for plug in coil;
- Two Pilot or *Silver-Marshall* plug-in coil forms;
- One *Silver-Marshall* "No. 123" shielded R. F. transformer, L4;
- One panel switch, SW1;
- One D. P. D. T. switch, SW2.

The variable condensers may be ganged together. If they are operated separately, C1 may be tuned by an ordinary knob; but (Continued on page 185)

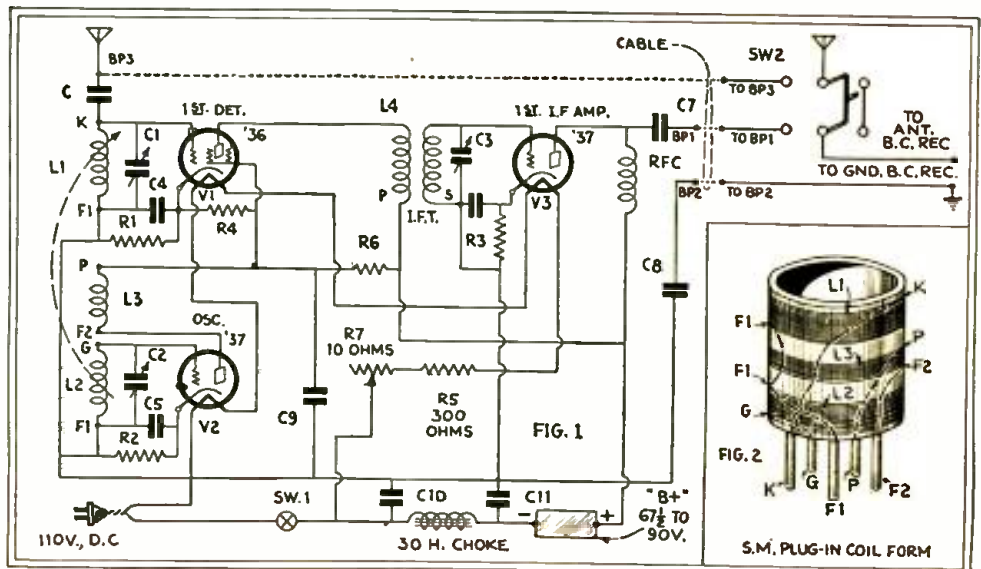

Fig. 1

This converter, with three of the new 6.3-volt heater tubes in series, was designed to work with a D.C. electric receiver; although it will be found flexible in its application. The "B" battery is used only with a 32-volt line. Right, connections of the plug-in coils.



# Short-Wave Converter Operation

(PART II)

*Some hints on improving reception with these popular accessories*

By RONALD LEWIS

**A**S explained in the preceding installment, the operation of a "super" converter depends upon a change of signal frequency; which is produced, just as in standard superheterodynes, by the interaction between a local oscillator and the received short-wave signal. The difference-frequency set up between these must be somewhere in the long-wave broadcast band (200 meters up); and it is then handled by the broadcast receiver just as if the signal had been sent out from the transmitter on a long wave.

## The Limits of Efficiency

A little reflection will show that a converter cannot work to advantage unless the broadcast receiver to which it is connected is both selective and sensitive. The writer wishes to emphasize this point; for it is one of the most important things in the successful operation of short-wave converters—to paraphrase: "Make sure your broadcast set is right, then go ahead."

While many receivers of present-day design are supposed to afford equal amplification and selectivity throughout their entire tuning range, it has been found that the region around 1500 kilocycles usually affords the best results. Therefore, when the R.F. section of the broadcast set is to be used as the I.F. amplifier of the converter output, the set's dial is to be turned to this frequency setting; and only the converter's tuning dial adjusted to tune in the various stations.

Thus logging is possible, since only one dial, C1 (Fig. 1) is needed to tune in short-

wave stations. Of course, if a broadcast signal is found at the selected frequency, the broadcast set's dial must be shifted a few points. Only under exceptional conditions will it be found necessary to shift the broadcast dial to a higher setting.

As previously stated, since the success of the converter depends upon the efficiency of the broadcast set, volume and selectivity adjustments of the latter should be made with care.

After all connections have been made and the assembly turned on, a rushing sound should be heard. If this is not present, the receiver's volume control should be adjusted, either up or down; the latter, to control circuit oscillation which may exist in the broadcast receiver, and may be evident as a feeble hiss and lack of short-wave signals.

The dial of the converter should now be turned with extreme care. This procedure is of the utmost importance. It must be remembered that, if the broadcast set is selective, the converter will appear to be extraordinarily more so; and stations will be passed over if the dial is not rotated *slowly*. Even the loudest short-wave station that can be received, coming in very strong at a given position of the converter's dial, may be tuned out by a slight movement of the dial. (Fig. 3)

Let us now see what factors exist that may prevent the converter from performing satisfactorily.

## Faulty Converter Action

It will sometimes be found that the converter acts only as a *broadcast signal booster*, instead of a short-wave signal mixer. This is because the oscillator in the converter is not perking.

The first thing to check up is the tube. Strange as it may seem, it will be found to be the trouble maker practically every time. If you have no means of checking this up, your local dealer will help you out. If the tube is not the cause of trouble, the plate and filament voltages should be checked.

At this point we enter a new field. Some converters use the "B" voltage of the broadcast set; others are run from separate "B" batteries; and still others have their own "B" socket-power units. The use of the "B" voltage of the receiver will be discussed first.

If the receiver used is of the screen-grid type, the voltage is nearly always obtainable directly from the screen-grid lead of a tube. The looped end of the insulated converter lead, designated for that purpose, must be tightly wound over the screen-grid prong. Or, if a lug is at hand, the lead should be soldered to it and placed

on the prong, making sure that the contact is solid. It has been found that a connection made to the last R.F. amplifier screen-grid tube affords the best results; since the supply voltage is usually most constant at this point. (Fig. 4)

If the receiver uses only the "general

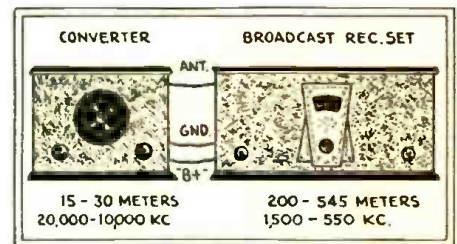

Fig. 3

*A division on the converter dial covers a hundred kilocycles, as against ten kilocycles to a division on the set.*

purpose" types of tube, such as the '26 or '27, the plate voltages are taken from any one of the plate supply circuits (in the radio-frequency section, of course). In this case, where the voltage is pretty high, it is well to insert, for a control, a variable resistor of about 10,000 ohms, and to bypass it. Too much voltage may cause the tube circuit to oscillate strongly, causing the same general effect as insufficient voltage.

In battery sets, the same methods of connection are followed for either screen-grid or standard type tubes.

## Current Supply

Now, if you find that you cannot pick up from your receiver a potential above 40 volts, a separate battery may be introduced. Its negative post connects to the ground and positive post to the "B+" lead of the converter. When doing this, it is also advisable to connect a 1-mf. condenser between it and the ground, to prevent circuit oscillation.

Converters necessarily occupy little space, into which the components will be almost crammed. A mistake in wiring is therefore easy, and frequently occurs. Be sure that the filament transformer's primary-secondary leads are not reversed. Keep this in mind when constructing or servicing converters.

If the converter (as shown in Fig. 1) has a built-in plate voltage supply, the rectifier tube, which may be either of the '27 or the '80 type, should be checked. The '27 type tube as a rectifier is becoming very popular, in view of the resulting compactness; because, also, only a small power transformer is needed. Ordinarily, when used as a rectifier, the '27's plate and grid  
(Continued on page 185)

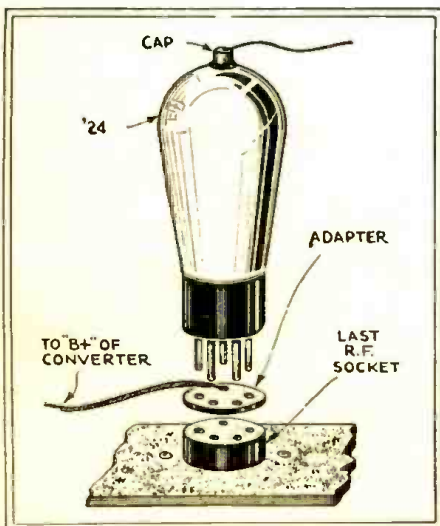

Fig. 4

*The method shown affords a method of taking plate voltage from a set for a converter. It may be necessary to pass the lead through a shield.*



# Pentodes and Their Use

(PART II)

*How to replace old-type power tubes with pentodes; and an explanation of the characteristics of the pentodes now available.*

By C. E. DENTON

**P**ART ONE of this article pointed out briefly that the pentode, with its high amplification, feeds directly out of a detector, giving an output larger than that of a three-element tube with similar

the peculiarities which must be taken into consideration in the design of its associated circuits, in order to obtain the desired results of high volume and quality. First, the construction of the tube must be considered.

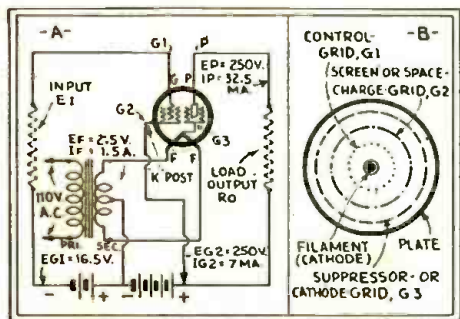

Fig. 4

Left, the fundamental connections of a pentode circuit; right, a cross-section horizontally through the elements.

voltages. For full utilization of the output of a screen-grid detector, two direct-coupled amplifiers were shown; one using a single '47-type tube; and one of the push-pull type. The latter is especially novel, being the first shown in this country.

It is interesting to note that, with this circuit, and with no more plate voltage than necessary for the '45-type tube, it is possible to obtain a power output of 5 watts with an input signal on the grid of the first pentode of only 16.5 volts (peak). Thus, if the voltage gain of the '24-type screen-grid input stage is at the low order of 100, and the signal on the grid of the first stage only 0.165-volt (peak), the amplifier will be working up to the limits of distortion in the pentode output stage. With larger inputs, the grids would draw current. (The gain in the average direct-coupled amplifier is generally greater than 100; so that the input signal under this condition will be less than the calculated value.)

It is the purpose of this article to analyze the efficiency of the pentode, and to explain

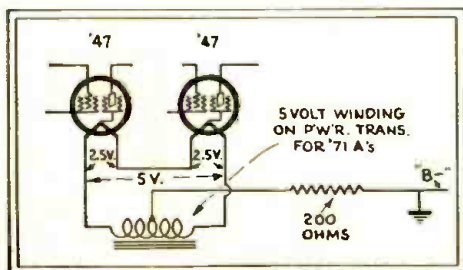

Fig. 5

Push-pull 5-volt tubes are easily replaced by two '47-type pentodes with filaments in series; biased by a 200-ohm resistor.

### Pentode Design

In Fig. 4A the elementary electrical circuit is indicated; while Fig. 4B shows the five electrodes in their proper relationship to each other, as seen from above. In dimensions, the A.C. pentode ('47) tube is the same as the '45 type, but it has a five prong base.

The efficiency, with which power variations in the output circuit of any tube are controlled by grid-voltage signal changes, is limited by the introduction of distortion. For undistorted power output, the plate power changes must be symmetrical with

In the pentode, the outermost or "suppressor" grid between screen-grid and plate is connected to the cathode, which may be the filament inside the tube. Being at the same average potential as the filament, the suppressor-grid has practically no effect on the flow of electrons from the filament to the plate; it is, however, negative in respect to the plate. This potential difference (between suppressor-grid and plate) is equal to the instantaneous plate potential; consequently, secondary-emission electrons, leaving the plate under the bombardment of the electrons from the cathode, find that the path back through the suppressor-grid is a difficult one. The greater portion of these electrons return to the plate.

### The Pentode as a Replacement

Many Service Men and experimenters will want to replace '71As or '45s by pentodes in standard radio sets and phonograph amplifiers. The first thing to be done is to replace the four-prong UX sockets with those of five-prong UY type. The pentode tubes are so based that the filament terminals are conventional; the control-grid connects to the "G" terminal and the screen-grid to the "K." The plate connection is the same as in the '27 type.

Of course, the filament requirements of the types '45 and '47 tubes are identical. In commercial radio sets with push-pull '71A's, which are to be changed to use pentodes, connect the filaments of two type '47 tubes in series across the 5-volt filament supply, and the biasing resistor (200 ohms) between the center-tap and "B-". The additional filament drain will not materially affect the operation of the power transformer; since these windings are generally

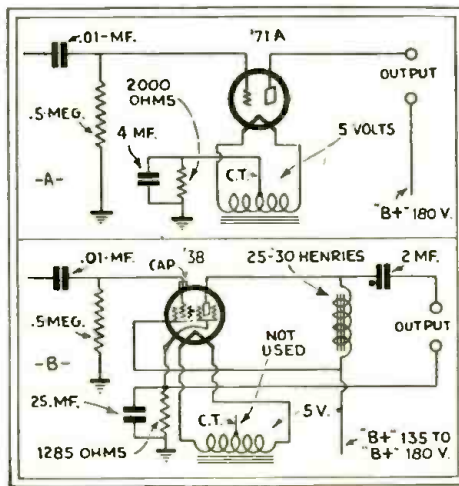

Fig. 6

A single '45 may be replaced by a '38, with lower maximum output, but more volume on weak signals.

the changes in the grid circuit; and the grid input potentials must be of such a value that the peak values do not exceed the bias applied to the grid.

The introduction of the space-charge grid, as in the regular "screen-grid" or '24 tube, nullifies only the effect of the "space-charge" between the filament and the control-grid; it materially arguments the action of the tube as a voltage amplifier, but offers no advantage in power amplifier circuits because of the high value of the "secondary emission." That is to say, electrons striking the plate at a high speed knock out of it additional electrons, which are attracted back to the screen-grid. This electron cloud, the "secondary emission," materially reduces the flow of electrons, thus lowering the plate current.

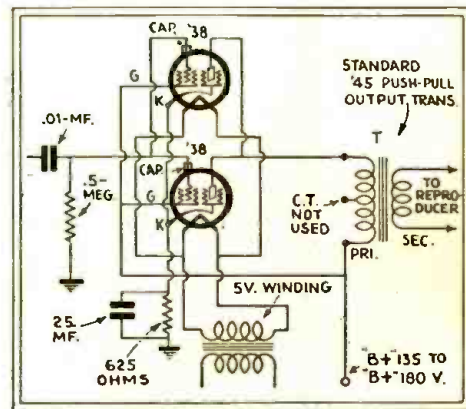

Fig. 7

This unusual circuit will make a good replacement for push-pull '71As; note the '38s are paralleled.



under rated; the total filament current consumption would be 1.5 amperes (Fig. 5).

The writer recommends the use of a single type-'38 pentode in place of a single type-'71A tube operating in A.C. sets, (Fig. 6) although the former tube is not designed for A.C. operation. The type '38 tube has its control-grid (like those of the '24 and '35) connected to a cap on the top of the tube; and it plugs into a type UY or 5-prong base; the "K" terminal of which is the cathode, "G" the screen-grid, "P" the plate, and "F, F," the two heater connections.

For the grid-biasing resistor, use a 1,500-ohm wire-wound unit with adjustable contact. In fact, for experimental operation, the usual 1,500-ohm resistor of the '71A may be retained.

For battery operation, the type '33 with a suitable filament resistor (say, a 75-ohm rheostat, on 6-volt storage "A" supply), or the type '38 tube connected directly across the battery, may be used. Use the same circuit as shown in Fig. 6B, substituting the 6-volt supply for the output of the A.C. secondary.

Tube data (voltages, current, etc.) are shown on page 759 of the June, 1931 issue of RADIO-CRAFT.

In substituting push-pull '47's for push-pull '71A's, as shown in Fig. 5, the output device may remain the same at a slight loss in power output; or one of the push-pull pentode output transformers designed for this service may be obtained from the manufacturer of the reproducer. Again, this transformer may be obtained from certain manufacturers of pentode output units, as mentioned above.

Here is a circuit (Fig. 7) which should gladden the hearts of tube makers, being a chance for the sale of two type '38 (or "cathode") pentodes. It is an ingenious method of obtaining good matching of the output circuit of two type-'38 tubes used in place of push-pull '71A's; the final circuit gives parallel, instead of push-pull operation of the '38's. Output transformer T will be a standard type '45 unit, offering in this arrangement an approximate match to the two '38's.

**Biasing Resistor Values**

The value of the biasing resistor for the single '47 or 1PZ pentode should be, theo-

retically, 418 ohms. This value is obtained by dividing the proper bias, 16.5 volts, by the combined plate and screen-grid current (32 milliamperes plus 7 milliamperes equals 39 milliamperes). A standard 400-ohm resistor is suitable; because the center-tap resistor across the filament adds slightly to its value. When pentodes are used in push-pull, the biasing resistor should have half the value of that for a single tube, or 200 ohms.

For the '38 tube, a similar calculation indicates a value of 1,285 ohms for a resistor biasing one tube, or 640 for one carrying the current of two tubes.

As the actual voltage gain of the pentode is about 14, compared to approximately 2 in the type '45, it is necessary to use a very high capacity to bypass the biasing resistor, to prevent "degenerative" effects at low audio frequencies.

The great voltage gain causes large signal voltages to appear across the biasing resistor and, since the latter is common to both the plate and the grid circuit, unless it is bypassed by a suitable capacity (in a single- or parallel-tube connection) the operation of the tube will be erratic and

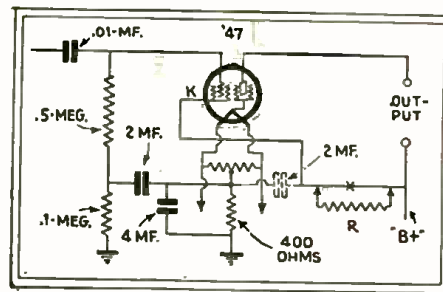

Fig. 8

Observe that the biasing resistor of a single pentode is low in value; and a high bypass capacity is therefore needed, to be an effective shunt.

the signal voltage, appearing on the screen-grid, from feeding back, through the common power supply, to other portions of the receiver.

Some receivers obtain biasing voltages from a voltage divider; in which case the total current consumed by the receiver, plus the bleeder current of the divider, flows through the biasing resistors. Some means must be employed to de-couple the grid circuit of the pentode tube; so that regenerative or degenerative action will not distort the frequency-response characteristic of the audio system.

**Choice of Output Coupler**

The selection of the output coupling device is a critical one; although quite satisfactory results have been obtained with the standard output transformers and chokes.

The load in the plate circuit for maximum undistorted power output should be 7,500 ohms for the types '47 and '33 tubes; and 15,000 ohms for the type '38. A 30-henry choke at 60 cycles has a reactance of about 10,800 ohms and, as the direct current for the plate of the tube flows through this winding, the reactance will be lowered with the drop in inductance. Thus the 30-henry choke, in conjunction with a 2-mf. condenser, is a fairly satisfactory output coupling.

This method of coupling is quite satisfactory with supersensitive receivers which display marked tendencies to sideband cutting. Receivers having this characteristic do not deliver large grid-voltage swings at high audio frequencies; thus compensating the increase of output which tends to occur in the pentode at high audio frequencies by reason of the increase in the reactance of the output load with the increase of frequency.

Output transformers should be selected (and now can be obtained from various manufacturers) to couple the pentode to the reproducer. The frequency-response characteristic can be more readily held within definite limits by the use of the moving-coil or dynamic type of reproducer; for the load impedance of the voice coil does not vary to such a wide extent over the audio range, as that of the magnetic type.

In push-pull operation, effecting even-harmonic cancellation in the output transformer, the total load for the types '33 and '47 tubes should be 15,000 ohms, and 30,000 ohms for the type '38 pentode. Other values of impedance may be utilized, calculated for the minimum generation of odd-harmonic distortion, but in the case of the type '38 pentode it is recommended by the writer

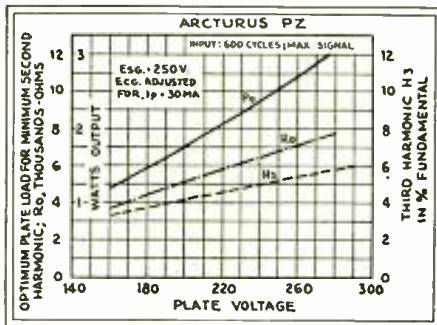

Fig. 10

The line H3 (third-harmonic) shows distortion; the line R0 the best value for the output load of a 1PZ or '47, at various plate voltages.

the quality of the output poor. (This precaution, however, is not necessary in push-pull arrangements, for reasons which have been explained at length in Mr. Messing's series on the push-pull circuit, previously cited.)

At least 4 mf. of capacity should be used across the biasing resistor, and much more if possible. A new type of electrolytic condenser, with a value of 25 mf., gives a high degree of efficiency at nominal cost and in reasonable space.

Many of the commercial receivers employ a resistor (R, Fig. 8) in series between the high-voltage "B" supply lead and the screen-grid connection of the pentode. The purpose of this resistor is to apply the same "B" voltage to the screen-grid as that which appears on the plate after the drop through the output transformer. In servicing receivers of this type, if the screen-grid resistor has been burned out, simply short-circuit the burnt-out resistor; for the voltage drop in the output transformer is not so great that it seriously interferes with the operation of the tube.

The insertion of a 1- or 2-mf. condenser, between the screen-grid connection and the center-tap on the filament of the pentode tube, (Fig. 8) will generally tend to stabilize the action of the audio end of the set as a whole; it tends to prevent any of

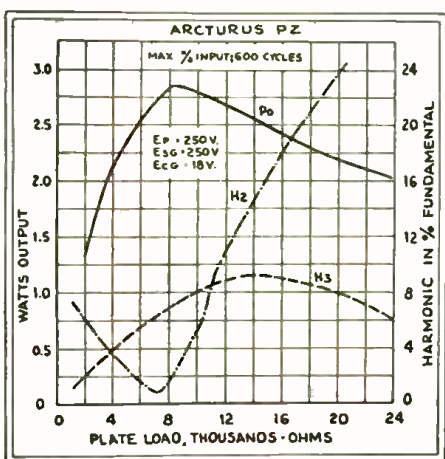

Fig. 9

This curve shows the effect of varying plate loads on a 1PZ or '47 tube; as regards power output Po, and second- and third-harmonic distortion, H2-H3 respectively.



that two of these tubes be used in *parallel*, instead of push-pull, for the same relative degree of fidelity.

**Plate Loads and Quality**

In usual practice, the three-element tube, or triode, has in its plate circuit an external load equal to twice its internal A.C. plate resistance  $R_p$ ; this value gives the maximum *undistorted* power output. The external load of the pentode, however, should be about *one-quarter* of its internal resistance  $R_p$ . This will be appreciated on examination of Fig. 9, which gives the curves of output wattage and harmonic distortion for various plate loads of the type PZ pentode (which is equivalent to the '47 for practical purposes.)

In this graph,  $P_o$  represents the fundamental or input signal frequency; H2 the second harmonic of the fundamental, and H3 the third harmonic. The creation of the harmonics in the action of the tube gives rise to distortion; the degree of which, accepted as permissible, limits the "undistorted" output. The rapid drop in H2, as the plate load is increased, reaches a very small value at 7,500 ohms and then increases again until, at a little over 16,000 ohms, it intersects the fundamental at 2.3 watts. The third harmonic H3 increases continuously, until  $R_o$  is approximately twice the load impedance for minimum second-harmonic distortion; and beyond that it falls off again.

The use of the pentode in push-pull amplifiers with the proper output transformer will of course reduce the *second* harmonic distortion of the output stage; but *the load must still be in proportion* to minimize the *third* harmonic output.

Output transformers or chokes must have some means of regulating the "effective load" in the plate circuit; so that, at the higher audio frequencies, the harmonic distortion will not be augmented by the increase in the impedance of the load with the increase of frequency.

Fig. 10 indicates the undistorted output of the PZ and '47 pentode when operated at various plate voltages; it also shows optimum load impedance for minimum second-harmonic distortion and the degree of the third harmonic present. It is a noteworthy fact that the harmonic distortion does not increase proportionately with the input; but, as the maximum input is approached, the harmonic content of the output increases at a lower rate.

**Figuring Pentode Amplification**

The formula used in calculating the voltage gain of a pentode is the same as that used for a triode; it may be expressed as follows:

$$\mu^1 = \frac{\mu Z_o}{R_p + Z_o}$$

Where  $\mu^1$  is the voltage amplification;  $\mu$  is the amplification constant of the pentode;  $Z_o$  is the output impedance, and;  $R_p$  is the plate to filament impedance of the tube.

It may serve to clarify this simple formula, in the mind of the reader, to take an example and work it out.

However, before we are ready to make our calculation of the voltage gain of the

Plate impedance, 38,000 ohms;  
Transconductance, 2,500 micromhos;  
Amplification factor, 95;  
Power output, 2.5 watts.

Referring to these constants, and substituting the values in the formula, we derive the following data:

$$\mu^1 = \frac{95 \times 7,000}{38,000 + 7,000} = \frac{665,000}{45,000} = 14.79 \text{ (volts) gain}$$

We now are prepared to make the following comparison between the triode and the pentode:

	Pentode "PZ"	Triode '45
Voltage gain .....	14.7	2.3
Input signal (peak) volts....	16.5	50.0
Output, watts .....	2.5	1.4

The specified output from the '45 is that obtained with an external load, in the plate circuit, equal to twice the internal A.C. plate resistance. Both tubes are operated at 250 volts on the plate.

**Power Sensitivity**

Stuart Ballantine has defined the power sensitivity of a thermionic valve as the ratio:

$$S = \sqrt{P_o} \div E_g'$$

where S is the Power Sensitivity;  $P_o$  is the power delivered to the load;  $E_g'$  is the R.M.S. value of the A.C. sinusoidal voltage.

A comparison of the "power sensitivity" S of the new pentode with various modern power tube is given, as follows: it will be seen how high the figure for the pentode is.

Tube	$E_p$	$E_g'$	$P_o$	S
'12A .....	157.5	10.5	.195	.0594
'71A .....	180.0	40.5	.700	.0292
'45 .....	250.0	50.0	1.600	.0358
'47 or PZ .....	250.0	16.5	2.500	.1360
'50 .....	450.0	81.0	4.050	.0239

The pentode, while not an ideal tube, offers many practical advantages, especially in the small receiver; the outstanding advantage being greater volume with reasonable tone quality. Forthcoming issues of RADIO-CRAFT will contain additional information about this interesting type of tube. Meanwhile, the references previously mentioned in this article should be consulted.

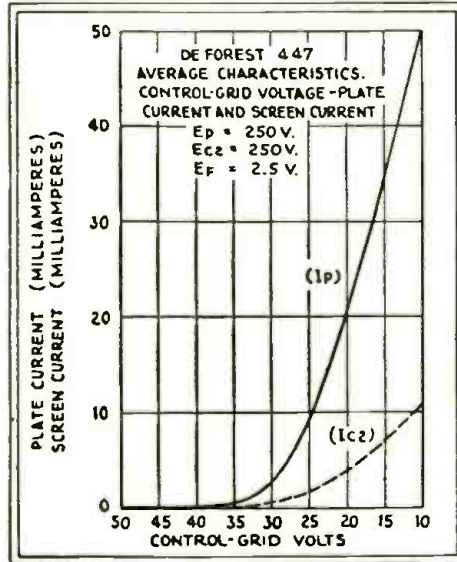

Fig. 11  
Observe the steep "slope" of the  $E_g$ - $I_p$  characteristic, showing the high mutual conductance of the pentode.

pentode, it will be necessary to have available all the operating characteristics of the tube. These are tabulated below, for the "PZ" type.

- Filament potential, 2.5 volts;
- Filament current, 1.5 amps.;
- Plate potential, 250 volts;
- Plate current, 32.5 ma.;
- Control-grid negative bias, 16.5 volts;
- Space-charge-grid potential, 250 volts;
- Space-charge-grid current, 7 ma.;
- Suppressor— (or "cathode—") grid potential, 0 volts;

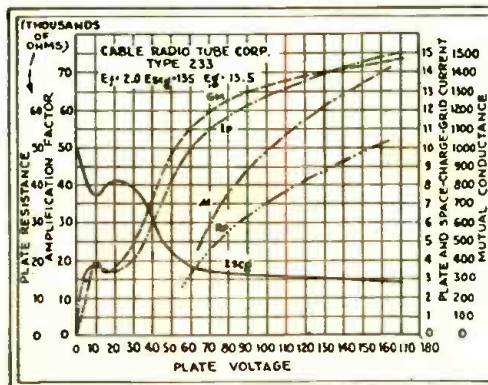

Fig. 12

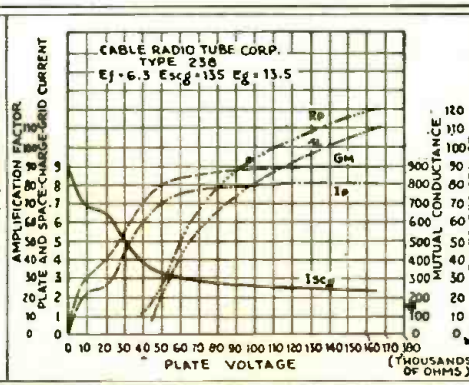

Fig. 13

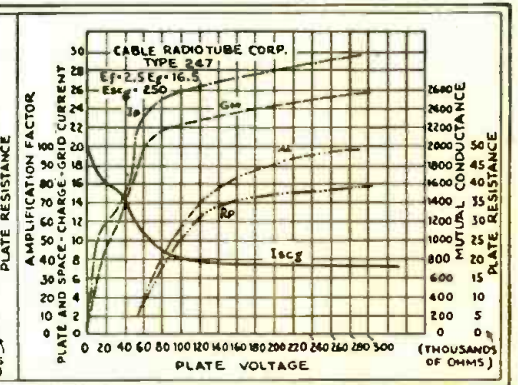

Fig. 14

The three standard types of pentodes, now available in the American market, have differing characteristics, yet their curves exhibit a family resemblance at different values. These curves, plotted for the "Speed" tubes, will be informative to the technician who will study them carefully, and compare them with the corresponding characteristics of other power tubes.

# Single-Control Design for Superheterodynes

*Some information on recent developments which will interest the constructor*

By C. H. W. NASON

**S**OME new facts concerning the superheterodyne circuit are still lacking in clarity, so far as the technician is concerned. It is the writer's purpose in this paper to cram as much information as possible into a few words; and the reader must bear up under the strain as we skip merrily from fact to fact.

In the normal broadcast receiver, two factors involving the term "selectivity" are encountered. First, we are concerned with simple or numerical selectivity, as determined by the relative "sharpness" of the individual tuned circuits involved, and their number (Fig. 1).

Also, since the adoption of the screen-grid tube, we have had to deal with a factor involving "cross-talk," or "cross-modulation" by a strong undesired local carrier. Where we are seeking to avoid "cross-talk," we are concerned with the numerical selectivity factor of the circuits ahead of the first R.F. tube's grid. Except in isolated neighborhoods, far from all broadcasters, it was fairly well established that one cannot expect freedom from the effects of cross-modulation if less than two tuned circuits precede the first tube.

### Use of Variable Mu Tubes

The new "variable mu" tube has, of course, changed this; and we may now operate successfully receivers with a single tuned circuit ahead of the first tube, or even with an antenna coupling of the untuned type, familiar to those who have worked with the early single-control receivers. It is certain that no receiver may be operated successfully in a congested area with an untuned antenna coupling, unless these new tubes are employed.

We are therefore concerned, in tuned radio-frequency receivers with selectivity of two kinds—or with one kind if we use the new tubes. Even though we employ the variable-mu tube with a superheterodyne re-

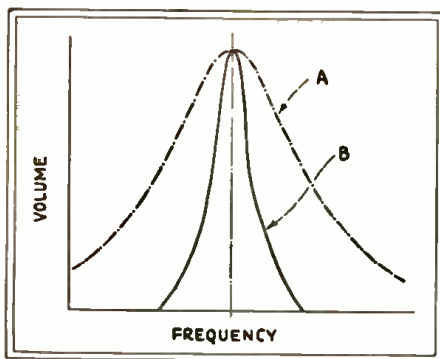

Fig. 1

The well-known curves of selectivity: A, that of a single circuit; B, that of three. The wider the bottom of the curve, the more opportunity for "cross-modulation."

ceiver, we must consider the "image-frequency selectivity," of which you have probably heard, and to obtain which it is essential that the numerical selectivity ahead of the first detector be of a relatively high order.

The entire basis of superheterodyne operation is the fact that two oscillations may be combined to produce both sum- and difference-frequencies, and that one of the latter may be amplified in a fashion more economical than is usual with tuned R.F. receivers. In order to receive a 1000-ke. signal, we combine it with a local oscillation of 1175 ke. and amplify the resultant 175-ke. oscillation which (as the difference-frequency) is present in the mixing circuit. Note now that, should another oscillation differing from the local-oscillator by 175

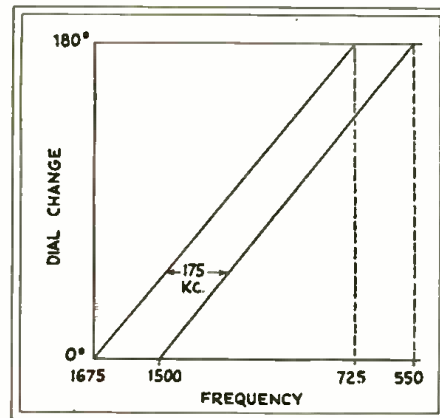

Fig. 2

The ideal (not actual) tuning curve of a superheterodyne — absolute straight-line-frequency variation with the oscillator 175 kilocycles above the detector tuner.

ke. or from the desired station signal by 350 ke., be present in the mixer, modulator, or first-detector circuit, an undesired 175-ke. component (the "image frequency") will be fed into the I.F. amplifier. The magnitude of the signal required to produce this type of interference is small and, inasmuch as it is received ahead of the mixer circuit, no amount of numerical selectivity in the intermediate, 175-ke. amplifier stages will assist in ridding us of it. It is necessary, therefore, to include at least two tuned circuits ahead of the mixer stage in a superheterodyne receiver; even though we may employ the variable-mu tube to avoid the effects of "cross talk."

### Single-Control in the Super

In the original single-control superheterodyne receiver, single control was achieved by placing in parallel with one of the tuning condensers, or the oscillator condenser, a midget condenser which was varied by means of an eccentric cam attached to

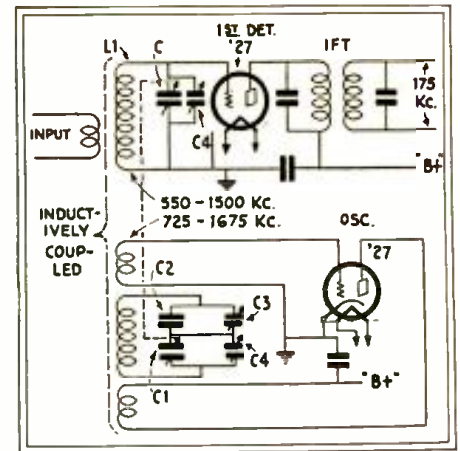

Fig. 3

The tuning circuit described by Mr. Nason. Constants for single-dial tuning are given in the text.

the main tuning shaft. This eccentric was cut to any shape necessary to the alignment of the circuits, but the cutting of these cams was a tedious process and hardly suited to production needs.

It then seemed probable that the use of straight-line-frequency condensers, with the inductance values in the tuning and oscillator circuits proportioned to give tuning curves separated by the desired beat-frequency, would produce the desired effect.

Unfortunately things are not quite so simple in practice, although the theory was perfect. The tuning curves of the oscillator and tuning circuits must be as shown in Fig. 2, and this relation must be held constant within exceedingly narrow limits.

In cases where the difference-frequency is low—that is to say, where the intermediate-amplifier stages are operated at some frequency below 100 ke.—the use of straight-line-frequency-condensers offers a solution to the problem. The stringent circuit requirements of the superheterodyne, however, demand a somewhat higher intermediate frequency; and we immediately run into difficulties in dealing with circuit capacities and small inductance variations, which begin to affect the efficiency of the system as the intermediate frequency rises. At 175 ke., a small variation in the total capacity of either circuit will result in a beat-frequency which is so far off, from that to which the intermediate amplifiers are tuned, that it causes a total loss of the signal.

We may, however, by a careful control of the inductance values and the stray capacities, employ a condenser having a specially-shaped rotor such that it gives a straight-line variation in oscillator tuning, in the manner illustrated in Fig. 2.

This is a strictly factory production proposition which requires fine control of all contributing factors, and is decidedly not for the home constructor. Some enterprising manufacturer might achieve fame and slight fortune by offering the fan a unit comprising condensers and coils calibrated at the factory. The fortune involved would be small compared with the fame—and fame is an asset of rather intangible value in these days of commercialism. The answer to the problem is given by the use of a network of the type familiar to those who have worked on the new supers or studied their circuit arrangements.



**A Circuit-Balancing Arrangement**

Fig. 3 shows the elementary arrangement of a mixer circuit to be employed in producing a beat of 175 kc., at all points in the tuning range, between an incoming signal and a local oscillation. The incoming signal may lie within the range from 550 to 1500 kc., and the range of the oscillator will vary at the same time over a range from 725 to 1675 kc. The theoretical considerations involved are too complex for

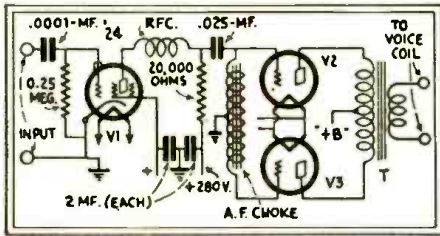

Fig. 4

A method of coupling designed to give good low-frequency quality, with a screen-grid detector feeding a push-pull stage.

review here, but it will suffice to say that a rule for the type of network shown in the circuit has been worked out experimentally. This states that, if the tuning condensers C and C1 are alike, and C2 is made just twice the value of C at its maximum setting, for an oscillator inductance 22% less than L1 (this value is not critical) the rate of change of the total capacitance in the oscillator circuit will be such as to give effectively the tuning curves outlined in Fig. 2. The two small variable capacitors C3 and C4 are simply midget condensers of the usual type, which are employed in aligning the circuits at the high and low wavelength ends, respectively, of the tuning range.

The trimmer condenser C4, across the tuning section of the oscillator network, adjusts the minimum capacity of the system, and thus effects an alignment of the oscillator circuit at the high-frequency end of the range. The other trimmer C3, across the fixed condenser, serves to effect a similar alignment at the low-frequency end of the spectrum. Tracking throughout the mid-range will be perfect enough to avoid any necessity for the use of a manually-operated trimmer while tuning. (Compare the circuit of the Philco "111," shown in Data Sheet 45 in the July issue of RADIO-CRAFT.)

**Purity of Oscillations**

It matters little what type of oscillator is employed, so long as its output is substantially free from harmonics and it will permit of changing tubes without serious disalignment of the circuits.

The circuit shown has been employed in one of the more recent commercial supers. The present writer claims sponsorship for the idea in the popular press, as it was used in the design of a signal generator described in *Radio Engineering* a year ago. The idea is not, however, original with him; for it was shown to him some years ago, and has been since employed in every oscillator he devised, because of the remarkable merit of the system, so far as frequency stability and harmonic output are concerned. This is particularly true in battery-operated sets where the changing voltages, due to running down of batteries, will seriously affect

(Continued on page 182)

# Short-Wave Inductances and How to Figure Them

## (PART II)

**A**T high frequencies, the inductance of a coil is less than at the lower; in addition, capacities are slightly less. The first effect is due to the "skin effect," which keeps current from flowing at full density in the interior of the wire; the second to the fact that no dielectric is perfect. However, neither variation amounts to more than seven per cent, at most, and they may be neglected in the approximations which are made here; since outside capacities and inductances are more important than slight variations in the short-wave coil.

As stated in the preceding installment, the short-wave bands are usually covered by from three to five sets of inductances. More efficiency may be obtained by "spreading the bands"; but more coils and more changing are required. Four seems to be the most popular number.

**Determination of Inductance**

Suppose our bands to be from 13.6 to 30 meters; from 27.3 to 60 meters; from 57 to 111 meters; and from 103.4 meters to 200 meters. (The tuning condenser does not give the same ratio over the higher band, because there is a larger coil capacity in shunt across it.)

Our top LxC product, for the lowest band, is 253.2; that is, the product of the maximum capacity of our tuning condenser (plus the distributed capacities around it) by the inductance of the coil, must be at that figure. Say we have a 100-mmf. condenser; its minimum capacity is 6 mmf., and the total miscellaneous capacities are 18.3 mmf. Our coil, at maximum, is resonated by a total of 118.3 mmf. capacity in parallel; it must therefore have an inductance of 2.14 microhenries.

A two-inch coil, wound 11 turns to the inch, will have an inductance, according to our first formula, of 2.3 microhenries, with 5½ turns; according to the second, slightly less. However, and as a matter of fact, it is probable that some of this will have to come off. Our leads have not only distributed capacity, but also inductance; and this is impossible to calculate. We may also find it difficult to tune down to our theoretical minimum of 22,000 kilocycles; below 15 meters short waves begin to present special difficulties.

The accompanying tables of inductance, for different windings, are based on theoretical calculations and cannot be taken as practically accurate to the degree that a table of broadcast-wave coils is accurate. But it will be a guide to some extent; especially as the waves are longer.

With larger coils, the residual capacity of our circuit is somewhat larger. At 60 meters, our LxC figure is 1015; we may therefore figure on an inductance of 8.4. We shall require about thirteen turns. For 111 meters, the LxC is 3,500; about 27 turns, spaced 17 to the inch, are indicated. The highest band, reaching to the broadcast range, corresponds to an LxC maximum of,

say, 11,500; and around 45 turns, spaced 33 to the inch, should cover this.

The minimum of each band, however, is less easily predicted at short wavelengths, because it is affected more by unpredictable circuit connections. Even with accurately calibrated condensers and uniformly wound coils, painstaking adjustment is usually necessary to make the dials of short-wave receivers track.

For the further information of our readers, we also republish the coil data of various well known sets and kits for comparison. The bands covered are approximated.

**Inductance of Leads**

For instance, straight wire has inductance; this increases in greater proportion than its length. Six inches of straight No. 26 wire has an inductance of about one fifth of a microhenry; 24 inches, 0.924-microhenry; 48 inches, 2.02 microhenries.

If we wind the 24 inches into six turns of a 1¼-inch coil (spaced 17 to the inch) we increase the inductance only to 1.57 microhenries; the 48-inch length with twelve turns will go up to 4.43 microhenries.

(Continued on page 186)

TABLE VI

DESIGN OF COILS USED IN SHORT-WAVE RECEIVERS:			
Pilot "Super-Wasp," tuning capacities 100-mmf. (max.) in series with 01-mf., regeneration capacity 250 mmf. Diameter of form, 1-3/8 inches.			
Meters Covered (Approx.)	Antenna Coupler Turns	Detector Coupler Grid Ticker (spaced 1/8 in.)	
14.5-27.0	4½ No. 24 DCC	3½ No. 24 DCC	4 No. 24 DCC
26.6-50.0	9½ " " "	7½ " " "	6 " " "
48-100	20½ " " "	17½ " " "	7 " " "
100-200	46½ " " "	46½ " " "	15 " " "
Hammarlund, for tuning capacities 125-mmf.; regeneration 100 mmf. Diameter of form, 2 inches. Windings separated 1 turn.			
Meters	Grid Coil Turns	Plate Coil Turns	
14-24	3 No. 16 DCC	3 No. 16 D. S. C.	
22-40	7 " " "	5 " " "	
38-65	13 " " "	6 " " "	
60-110	24 No. 18 "	12 No. 18 "	
No. 16 wire spaced 11 turns to inch; No. 18, 17 turns. Variable primary of 6 two-inch turns, used with all coils, is 1 15/16 inches to diameter, hinged.			
Silver-Marshall "Midget," for 140-mmf. tuning capacities. Diameter of form 1 inch; primary (ticker) wound in slot. Forms threaded 59 turns to inch.			
Meters:	Tuned Secondary Turns	Primary Turns	Ticker Turns
15-31	6½	5 2/3	
30-57	13½	7 2/3	
55-104	25½	12 1/3	
105-195	46½	25 2/3	
"Craft-50m" tube-base coils, home-made. Forms 1 3/8-inch. Tuning capacity 32-mmf. Regeneration capacity, same. Windings separated 1/8-inch.			
Meters	Tuned Secondary Turns	Ticker Turns	
18-25	7 No. 28 DCC	7 No. 28 DCC	
25-35	10 " " "	10 " " "	
38-48	15 " " "	14 " " "	
45-65	20 " " "	18 " " "	
65-100	30 " " "	30 " " "	



# The Design of Power Transformers

*With tables and charts for the easier finding of wattages, voltages, number of turns, wire sizes, etc.*

By C. W. PALMER

**W**HEN, some time ago, the writer first thought of preparing an article on the design and construction of transformers for the power supply of radio receivers, some doubts arose regarding the usefulness of such a collection of data. However, on making a survey among a number of Service Men, it was found that a great deal of interest would be shown in the actual details, without too much mathematics.

For this reason, a number of tables and charts have been developed from the usual transformer formulas. (Trial coils have been made, to verify the results.) In this way, much tiresome calculation has been eliminated; and, since the charts cover a wide range of power requirements, it is felt that the construction of the transformers commonly used for power-supply purposes has been covered. The usual description of the theory of operation has been dispensed with, since it is assumed that the reader is familiar with these fundamentals.

In general, two types of transformers are in use; both are shown in Fig. 1. The "core" type of construction is the more convenient to assemble; the "shell" type is more compact.

### Determination of Wattages

It is customary to rate transformers in watts; the wattage required for the operation of a radio receiver may be determined with the aid of the first tables. Table I gives the filament currents and wattages drawn by standard tubes, not forgetting the consumption of current by the center-tapped resistors. From this the current drawn by each low-voltage secondary winding may be determined; including that for the rectifier.

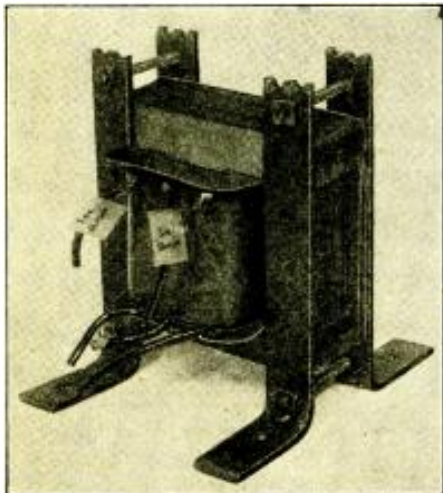
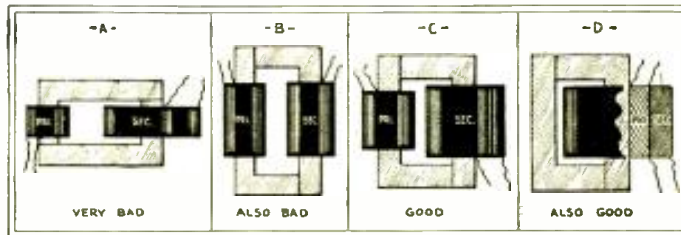

Fig. A

The "shell" type transformer above has been insulated with empire cloth between windings. It is highly efficient.

In addition to this, there is the high-voltage winding which supplies, through the rectifier, direct current to the plates, screen-grids, etc., of the set. The general needs of the receiver may be determined by adding together the plate wattages of the different tubes (see Table II, which takes into consideration the drop of voltage through grid-biasing resistors) and the bleeder current drawn by fixed resistors in parallel with the tube system. This last factor must be determined by examination of the circuit; but bleeder losses will usually run from ten to twenty milliamperes.

Having found the "B" current consumption of the set, it must be remembered that there is a loss of about 40% in power through the rectifier and filter system. Take, therefore, the figure indicated by



"60% efficiency" in Table III; that is, if the voltage-divider system is to furnish 30 watts output, the high-voltage secondary winding must be capable of providing 50 watts input for the rectifier.

The high-voltage secondary, feeding into the rectifier tube, must furnish an A.C. voltage nominally equal to the D.C. output at about 63 milliamperes, in the case of an '80 tube feeding a standard rectifier; that is, 300 volts A.C., on each half of the secondary, to give 300 volts rectified D.C. output. At 20 milliamperes draw, the output voltage will rise to about 365; at 100 milliamperes draw, the voltage will go down to about 275. (See Fig. 2.)

It is well, in computing any winding, to leave a liberal margin above the minimum of material which will serve. Larger wire, larger cores, etc., give cooler and more satisfactory operation; and temporary overloads will be less injurious to the transformer.

### Calculation of the Primary

We have determined the voltages, amperages and wattages demanded for the secondary windings. The primary wattage must equal that of all the secondaries combined, plus an allowance for loss in transformation—that is to say, of current converted into heat.

The primary current depends on the efficiency of the transformer. For power ratings of 500 to 1500 watts, an efficiency of 95% can be expected. For 100 to 500 watts

Fig. 1

The "core" type of transformer is the easiest to make; the "shell" is more efficient.

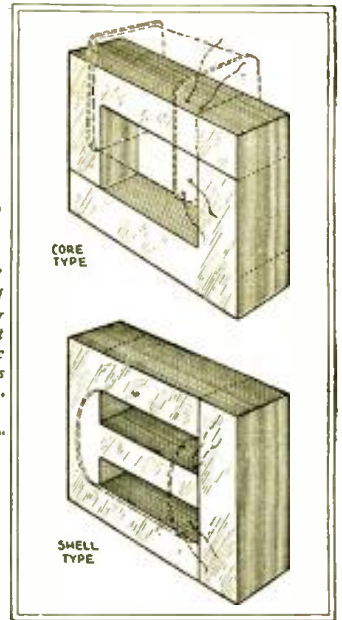

this drops to about 90%; while smaller transformers will probably be in the neighborhood of 85%.

To find the primary current, therefore, first divide the power output by the ex-

Fig. 5

Efficiency in a transformer is highest when the flux created by the primary is applied most intensely to the secondary, as in the examples at the right.

pected efficiency, which gives the required input power; Table IV may be consulted for the purpose.

Knowing the wattage of the primary, and the input voltage, which is determined, of course, by the power supply, we have only to divide the former by the latter to obtain the current which the primary windings must carry. A very quick approximation may be had by consulting Table III.

For instance, if the line-voltage is 115, and we are figuring on a 50-watt transformer, we find that the nearest value is



Fig. B

Tape and paper insulation has been used in the transformer above; the spools used in winding the coils are also shown.



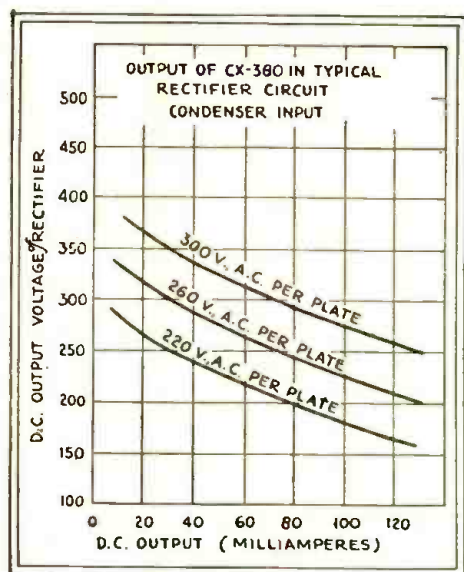

Fig. 2

Relation between input (A. C.) voltage and output (D. C.) voltage and current in an '80 rectifier (E. T. Cunningham Co.).

51.75 watts, which is opposite 45 milliamperes. This is near enough for our calculations of the primary.

The fundamental formula for a transformer's design is

$$T_p = \frac{E_p \times 100,000,000}{4.44 \times A \times B \times N}$$

Where  $T_p$  is the number of turns on the primary,  $A$  the cross-section of the core in square inches;  $B$  the flux density, per square inch of the cross section;  $E_p$  is the input voltage and  $N$  is the frequency.

To avoid the solution of this formula, two accompanying charts (Figs. 3 and 4) have been made. Fig. 3 gives the best number of turns for the primary, compared with the line-supply voltage and the rating in watts. A straightedge (the edge of a sheet of paper will do) is laid across the proper figures on the scale of volts at the left and the scale of watts at the right; it will cross the scale of "Number of Turns" at the proper value.

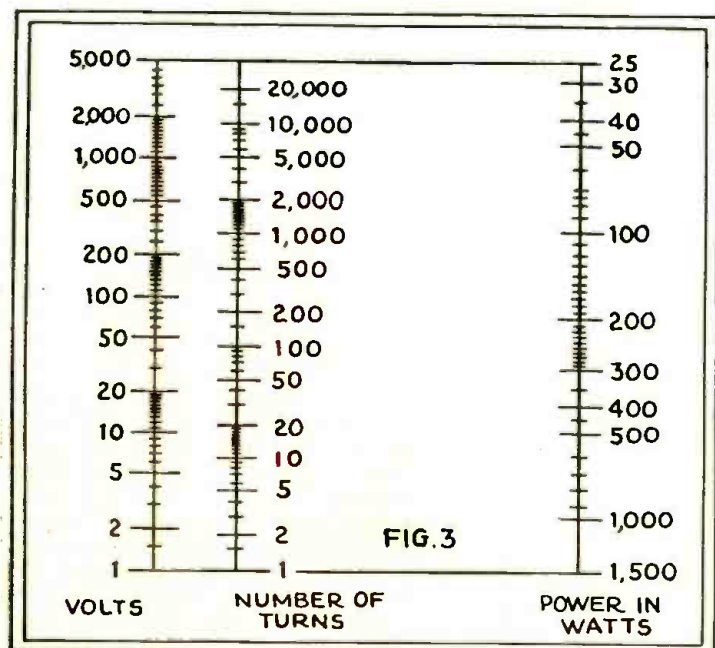

FIG. 3

These two charts are used to measure, as explained above: first, the number of primary turns needed; and second, the required size of core.

The corresponding size of core is found from Fig. 4 in a similar manner: take the number of primary turns, found from Fig. 3, and draw a line through the point on the scale indicating the voltage supply; the point on the scale at the right shows the area in square inches of the core, and one side of a square cross-section, in inches.

The value of the flux density—which is the determining factor of the core—as shown in the above formula, is estimated at 60,000 lines of force per square inch for the best grade of silicon steel. If the core is smaller, or of less permeable alloy, it is necessary to increase the number of turns of the wire.

TABLE I

FILAMENT WATTAGES :			
Volts	Amps.	Tube Types	Wattage (each)
1.50	1.05	'26	1.575
1.50	0.15	10-ohm resistor	0.225
2.50	1.50	'45, '47, PZ	3.750
2.50	1.75	'27, '24, '35, '51	4.325
2.50	0.125	20-ohm resistor	0.313
3.30	0.06	'99	0.200
3.30	0.15	'20, '22	0.400
5.00	0.25	'12A, '71A	1.250
5.00	2.00	'80	10,000
5.00	0.167	30-ohm resistor	0.833
6.30	0.300	'36, '37, '38	1.890
7.50	1.250	'10, '50, '81	9.375
7.50	0.250	30-ohm resistor	1.875

Secondary Windings

We now proceed to divide the number of primary turns, which we found from Fig. 3, by the primary voltage. This gives us the

"turns per volt"; and we may multiply the voltage desired from each secondary, by the "turns per volt," to determine the number of turns which that winding must have.

For instance, our primary voltage is 115, and there are 575 turns on the primary; this is 5 turns per volt. A 2½-volt secondary, therefore, should have 12½ turns; a 5-volt secondary, 25; and a 300-300-volt center-tapped secondary, 1500 turns on each side of the tap. In the design of filament windings, modern practice is to make the output voltage a trifle less than the rating of the tube, and thereby prolong the life of the latter. To the secondary winding, we add 5% to the number of turns for "regulation" (loss in transformation.)

We have now to determine the size of wire to be used, and design our core to carry the necessary number of turns, and the current which may be safely carried, by each gauge of wire. (Table V.)

The last column is based on the premise that 1,500 "circular mils" (the equivalent in cross-section of 1,500 wires, each .001-inch in diameter) should be allowed for each ampere of current flowing in the windings. (For a transformer to be used only intermittently, an allowance of 1,000 circular mils per ampere is sufficient; take wire two gauges smaller than that specified in the table). Determine the wire gauge required to carry the current of the primary, and of each secondary.

Example of Calculation

For instance, we are designing a transformer to supply all voltages for a receiver containing three '24 screen-grid tubes, two '27s (one the detector) two '45 power tubes, and an '80 rectifier.

A 2½-volt winding for the first five tubes must supply 8¾ amperes; it rates 22 watts.

A 2½-volt winding for the two power tubes must supply 3¼ amperes including ¼-amp. for the center-tapped resistor; this is 8½ watts.

The 5-volt winding for the rectifier supplies 2 amperes; 10 watts.

The combined plate and screen-grid current consumption of the '24s is 16.2 milli-

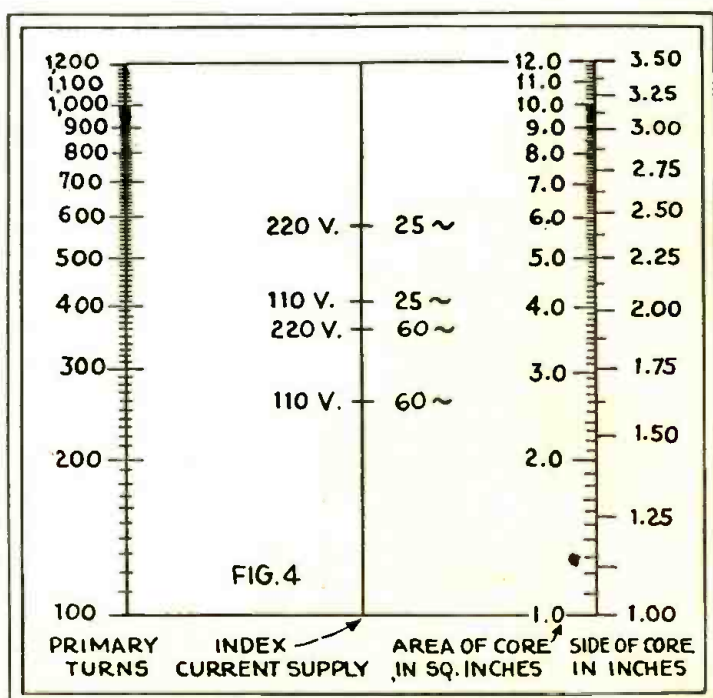

FIG. 4

amperes; that of the plates of the '27s, 5 ma. (the detector draws very little); of the '45s, 56 ma. Our voltage divider may draw 15 ma. ("bleed" current); giving a total of 92.2 milliamperes to be furnished by the rectifier, at a D.C. voltage of 330, to allow for the drop in the filter. We have therefore an output wattage from the rectifier of 30.4 and, since our efficiency is around 60%, as stated before, we must figure on a 50-watt A.C. input. This will require a high-voltage secondary giving 360 volts on each side of the center tap, and carrying an alternating current of 139 milliamperes.

Our primary, therefore, is called upon to supply 90.625 watts and, since it is working at an efficiency of not to exceed 85%, we may rate it for purposes of design at 110 watts.

By reference to Fig. 3, we find 460 turns for our primary, at 115 volts; or four turns per volt. Further calculation gives 10 turns for each 2½-volt secondary, 20 turns for the rectifier filament winding; and 1512 turns on each side of the center tap of our high-voltage secondary (1440 plus 5 per cent for "regulation").

The primary, carrying a current of 788 milliamperes, should not be smaller than No. 19 wire; No. 18 will do. The winding for the five heater-cathode tubes must be No. 9, or 8; that for the power tubes No. 13, or 12; the '80 is supplied through No. 15, or 14; and the high-voltage secondary should be No. 26.

We may, however, for greater flexibility and ease, wind together, in parallel, two No. 12 wires instead of one No. 9. We have now the task of accommodating our windings most compactly, together with their insulation, on a core of 1.58 square inches cross-section or 1.25 inches on a side; which is solved as explained below.

**Design of the Core**

All that remains is to design a core of required cross-section with an opening, or "window," large enough to hold all the coil layers, and the insulation between them.

This can be best accomplished by making a full-size sketch of the contemplated core, on a piece of paper. First draw one leg

of the core and assume a certain length for the primary winding. Then ascertain (by reference to Table V) the number of turns that can be wound per layer. As the size of the wire has been determined by the current in the primary, the number of turns per layer is calculated by multiplying the figure for the turns per inch (see the wire table), by the length of the winding, in inches.

After the turns-per-layer figure is obtained, it is divided into the total number of turns, to get the number of layers. This will give the winding size, which is then sketched over the drawing of the core leg. The estimate of the winding should include about ¼-inch for insulation over the core laminations. Space is also needed for a thin piece of paper between each layer of wire.

If the secondary winding is to be placed over the primary (D, Fig. 5) a space of ⅜-inch is necessary, for insulating tape between the two coils. The size of the secondary is figured like that of the primary, and the size of the winding is drawn in the sketch. As additional windings are used, allow similar space for insulation between each.

Certain shapes of transformers will result in best "regulation." (By "regulation" is meant the drop of output voltage when the transformer is under load.) Fig. 5 shows some of the recommended shapes; as well as some less desirable.

If your winding becomes too long for the depth, or *vice versa*, try a different length for the winding, and re-calculate the size. A little time spent at this point will be well repaid later.

**Construction of the Transformer**

After the coil and core dimensions are decided upon, the only remaining calculation is to figure the number of core laminations required.

Divide the thickness of the laminations into the size of one side of the core. For 60-cycle transformers, core material .014-inch thick is usually considered best. For 25-cycle transformers, a somewhat thicker core material may be used; but, with home-

TABLE II

Voltages:		Current	Tube	Watts
Plate	Grid	Ma.	Types	(each)
135	11.5	6.2	*12A	0.908
135	9.0	6.3	*26	0.908
135	9.0	4.5	*27	0.648
135	29.5	17.6	*71A	2.880
180	15.0	7.6	*12A	1.482
190	13.5	7.4	*26	1.432
180	13.5	5.0	*27	0.968
180	43.0	20.0	*71A	4.460
180	34.5	25.0	*45	5.390
250	50.0	34.0	*45	10.200
250	22.0	10.0	*10	2.720
250	45.0	28.0	*50	8.260
350	31.0	16.0	*10	6.100
350	63.0	45.0	*50	18.585
425	39.0	18.0	*10	8.350
450	84.0	55.0	*50	29.370

Voltages		Current	Tube	Watts	
Pl.	C.-G.	S.-G. Ma.	Type	(each)	
135	1.5	...	3.5	*36	0.478
135	9.0	...	4.5	*37	0.648
135	13.5	*135	10.5	*38	1.560
180	3.0	90	5.4	*24	0.968
180	1.5	75	7.0	*35	1.295
180	3.0	90	7.5	*51	1.375
250	3.0	90	9.0	*35	2.270
250	16.5	*250	40	*47, PZ	10.680

#Including Screen-Grid Current. • Pentode

TABLE III

Current Draw (Milliamps.)	V O L T A G E S								
	85	100	106	110	116	120	210	220	230
20	17	20	21	22	23	24	42	44	46
25	21½	25	26½	27½	28½	30	52½	56	57½
30	26½	30	31½	33	34½	36	65	66	69
35	29½	35	36½	38½	40½	42	75½	77	80½
40	34	40	42	44	46	48	84	88	92
45	38½	45	47½	49½	51½	54	94½	99	103½
50	42½	50	52½	55	57½	60	105	110	115
55	46½	55	57½	60½	63½	66	115½	121	126½
60	51	60	63	66	69	72	126	132	138
70	59½	70	73½	77	80.5	84	147	154	161
80	68	80	84	88	92	96	168	176	184
90	76½	90	94½	99	103½	108	189	198	207
100	85	100	106	110	115	120	210	220	230
120	102	120	126	132	138	144	...	...	...
140	119	140	147	154	161	168	...	...	...
160	136	160	168	176	184	192	...	...	...
180	153	180	189	198	207	216	...	...	...
200	170	200	210	220	230	240	...	...	...

Table III gives input wattages for a given current and voltage; Table II' the output (first column) for any input.

TABLE IV

INPUT WATTAGE ALLOWANCES				
Required Wattage	Percentage of Efficiency			
	60%	75%	80%	85%
25	41.67	33.33	31.25	29.41
35	56.33	46.67	43.75	41.18
50	83.33	66.67	62.50	58.83
60	100.00	80.00	75.00	70.59
75	116.67	93.33	87.50	82.38
80	133.33	106.67	100.00	94.12
90	150.00	120.00	112.50	106.88
100	166.67	133.33	125.00	117.65
120	200.00	160.00	150.00	141.18
150	250.00	200.00	187.50	176.47
200	333.33	266.67	250.00	235.30

constructed cores, it is probably best to use the same size as for 60 cycles.

The remainder of the design consists of laying out the core and windings as explained above. After the design is complete, the construction of the windings follows. Many suggestions have been published regarding methods of using hand drills, sewing machines and other devices to make the tedious job of winding more easy; this will be left to the constructor to decide.

There are several points in the construction of the coils which must be watched carefully. If enamelled wire is used, it is essential that a layer of insulating paper be placed over each layer of wire, for the primary and the high-voltage secondary. If cotton-covered wire is employed, this is not necessary for the primary; but, for the high-voltage winding, care should be taken to place a thin piece of paper over each layer, and carefully insulate the coil from the other windings and from the core.

The form for winding the coils should be made from stiff cardboard or, preferably, from thin fiber, in the form of a



spool with an opening slightly larger than the cross-sectional area of the core.

In some transformers, an electrostatic shield is placed between the primary and the secondary windings. It consists of a thin strip of copper or brass as wide as the length of the winding. It is wrapped over the primary coil before the secondary is wound and it is insulated very carefully

TABLE V

TABLE OF MAGNET WIRES					
Gauge B&S	Turns per Inch		Feet per Pound		Current Amperes
	D.C.C.	Enam.	D. C. C.	Enamelled	
6	5.4	5.7	12.3	12.6	17.5
7	6.1	6.5	15.5	15.9	13.8
8	6.8	7.3	19.6	20.0	11.0
9	7.6	8	24.6	25.2	8.7
10	8.5	9	30.9	31.8	6.9
11	9.6	10	38.8	40.1	5.5
12	10.6	11	48.9	50.5	4.4
13	11.9	12	61.5	63.8	3.5
14	13.1	14	77.3	80.4	2.7
15	14.7	16	97.3	101.4	2.2
16	16.4	18	119	128	1.7
17	18.1	21	150	161	1.3
18	20.0	23	188	203	1.1
19	21.8	27	237	257	0.88
20	23.9	29	298	323	0.88
21	26.2	32	370	408	0.54
22	28.6	36	461	515	0.43
23	31.1	40	584	648	0.34
24	33.6	46	745	817	0.27
25	36.2	50	903	1,031	0.21
26	39.9	57	1,118	1,300	0.17
27	42.6	64	1,422	1,639	0.13
28	45.5	71	1,759	2,087	0.11
29	48.0	81	2,207	2,807	.084
30	51	88	2,534	3,287	.087
31	57	104	2,768	4,145	.065
32	60	120	3,137	5,257	.042
33	64	130	4,098	6,591	.035
34	69	140	6,168	8,310	.026
36	79	190	7,877	13,210	.017
38	89	205	10,666	21,010	.010
40	102	250	14,222	35,430	.008

from both. (Caution: Its edges must not be allowed to touch, for this "shorted turn" would greatly overload the primary.) Its purpose is to overcome line noises and static pick-up in the receiver through the power supply. It is usually connected to the overall shield can around the transformer, and is grounded in this way.

There are a number of sources for transformer laminations; some companies make a specialty of supplying a large number of sizes at reasonable prices. If a suitable size cannot be obtained, the sheet steel can be cut, by a tinsmith, to the required dimensions.

Some experimenters may have on hand old transformers with suitably-sized cores which may be adapted to the job, with some juggling of the coil sizes. It is best not to crowd the coil into too small a space; better results can be obtained by using more insulation in order to fill the "window" space.

One safe rule to follow is to figure high rather than low when in doubt about the dimensions of the core, wire, etc.

# Seeing "Sound Waves"

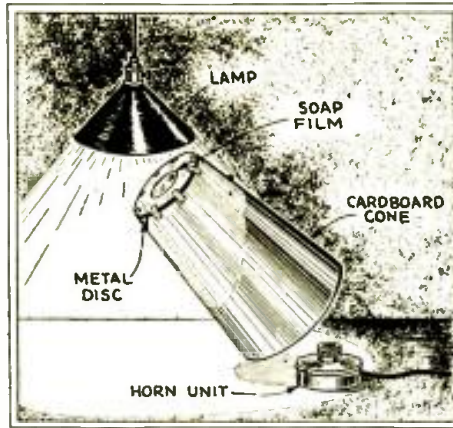

Fig. 1  
A simple method of examining the patterns formed by sound waves in a diaphragm.

LOUD-SPEAKER diaphragms, so experts tell us, do not vibrate as a whole, except at very low frequencies. As the frequency goes up, the diaphragm begins to vibrate in sections (like the string of a musical instrument which is emitting overtones); the result is that extraordinary patterns are formed on its surface. These are, of course, difficult to see on the cone of a standard loud speaker; but a very interesting experiment described by *Amateur Wireless* (London) may interest our readers.

The vibrations are made visible by the arrangement of Fig. 1; a horn unit is shown here, but the reader who has a loud speaker

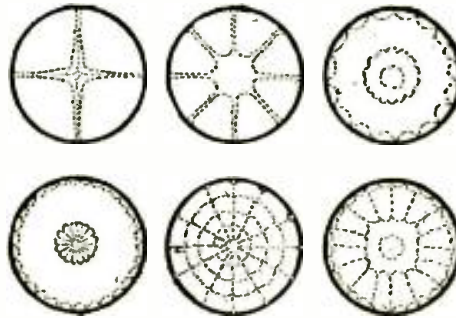

Fig. 2  
Some of the patterns formed in the film by audio notes. A reproducer diaphragm also vibrates in similar, but invisible segments.

which can be conveniently up-ended, may use that instead. The cardboard cone is made about nine inches long, and about 3 inches in diameter at its smaller end, which is closed with a ring-shaped piece of sheet aluminum (preferably), thick enough to be fairly rigid, and with a central hole from 1 to 1½ inches in diameter. The metal is sealed to the cardboard cone, say with gummed paper; closing the opening in the cone airtight.

A strong solution of soap, preferably in distilled water, is then made more viscous with about 5% of glycerine; and a soap film is formed (just as with a clay pipe) over the opening in the metal disc. By holding this as illustrated, at an angle of 45 degrees, under a strong electric light,

and over the reproducer, the sound waves are communicated to the soap film.

Some of the visible effects, lacking of course the color of the iridescent film, are illustrated in Fig. 2. As the musical tones become more rich, the patterns increase in intricacy; while low, sustained notes give comparatively simple designs.

## IMPROVING TREBLE QUALITY

By C. H. W. Nason

ALTHOUGH the fine reproduction obtainable with modern radio receivers points to the fact that a high-note limit of 5,000 cycles does not necessarily limit the quality of the program, to render speech and music with absolute fidelity demands that all frequencies up to 7,000 cycles be reproduced. To this end, the present telephone circuits, feeding broadcast stations, have been equalized over this range.

Although neutralization in A.F. circuits has been carried out for some years past, little has been written in the popular press concerning this phase of the problem. The high-frequency response of an amplifier is limited by many factors—paramount among them being the inter-electrode capacity of the vacuum tubes. The capacity from grid to filament of a tube is one thing when directly measured on a capacitance bridge—it is quite another under operating conditions; being many times the "geometrical" capacity measured in a non-operating condition. This additive effect is caused by the feed-back of an out-of-phase voltage through the grid-plate capacity of the tube. In audio amplifiers employing one or more stages of push-pull amplification, the high-frequency response may be greatly increased by cross-neutralization of the inter-electrode capacity of the tubes.

The new Hammarlund "MC-S" midjet condensers, fitted with set-screws for locking adjustments are ideal for this purpose. The schematic of such a stage of amplification is shown in Fig. A; this has been reduced in Fig. B to the form of an equivalent bridge of readily understandable form.

If, in such a bridge circuit, the capacities are equal, they will so balance that they do not affect the voltage transfer across the bridge. In order to reduce the tube capacities to harmless proportions, it is

(Continued on page 188)

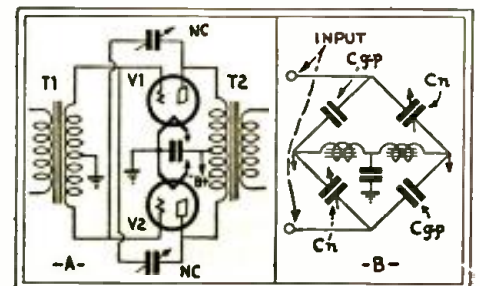

Left, the method of neutralizing a push-pull power stage described above; right, the equivalent bridge circuit formed thereby.

# The Radio Craftsman's Own Page

*What our experimental readers have found out for themselves*

*(Letters concerning hookups asking further details, etc., should be addressed to the writers of these letters, directly)*

## CHANGES IN COIL DESIGN

Editor, RADIO-CRAFT:

I am wondering how many radio fans tried winding their own coils in building the "Roll-Your-Own" according to the directions. I bought a set of the Pilot No. 176 coils, and find they are only 1 1/4 inches in diameter, instead of 1 1/2-inch, as mentioned. If anyone had trouble, they might find it here. A quarter of an inch might make a lot of difference.

E. LANDIS,  
Pocell, Nebraska.

(A checking of the figures indicates that the 1 1/2-inch diameter is needed for the number of turns given—98 of No. 28 D.S.C. wire—and that 1 1/4 would be too small. A measurement of a Pilot "Wasp" coil shows that the windings are 1 1/2 inches in diameter, on a 1 3/8-inch tube base. Later coils, it would appear, are smaller; but the number of turns has been increased to correspond with the inductance required for a similar tuning capacity.—Editor.)

## CONDENSER CAPACITIES

Editor, RADIO-CRAFT:

Mr. Denton's article on page 37 of the July issue is one of the best I have ever read and should occupy a place in every one's scrap book. Please see if you cannot get him to go a step further and duplicate these tables, but cover the wave band from 15 to 199 meters. (See article in this issue.)

There is one more connecting link that I would like to see published; and then we beginners would have a closed book. It is a common thing to pick up an old variable condenser, out of some scrap pile, whose capacity is unknown; and there seems to be a general understanding that a certain number of plates indicate a certain capacity. If an article could be published showing what capacity a certain number of plates indicate, and have it cover the capacities used between 15 and 545 meters and especially those between 15 and 200 meters, I think it would be appreciated and would fit in nicely with Mr. Denton's article.

I. W. RYKERT,  
6 Fairmount Ave.,  
Batavia, New York.

(Unfortunately, the answer is not as simple as this. In the old days, a 43-plate condenser meant .001-mf.; a 23-plate condenser,

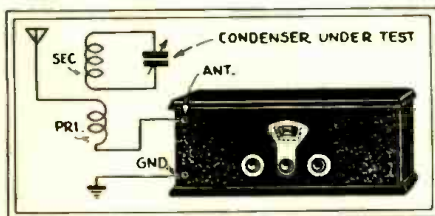

A method of using a receiver as a wavemeter to determine the value of a condenser.

.0005-mf.; and a 17-plate condenser, .00035-mf. or thereabouts. But the demands for compactness, etc., have produced condensers with different sizes of plates. For instance, one well-known line of midjets runs like this: 43-plate, 320 mmf.; 34-, 260; 27-, 200; 19-, 140; 14-, 100; 11-, 80; 7-, 50; 5-, 35; 3-, 20. One way to determine a condenser's capacity is to put it across a coil in wavetrapp style and note, with the aid of a receiver, its resonant frequency at maximum setting, or nearly so; the coil's inductance may be tested with a condenser of known capacity.—Editor.)

## REGULATE YOUR LINE-VOLTAGE

Editor, RADIO-CRAFT:

Here is a slight variation of an old kink which I have been using for some years, and which may benefit some beginners. I am so unfortunate as to live in a community where our line voltage drops to 90, and even 85 volts from dark until about 10 p.m.

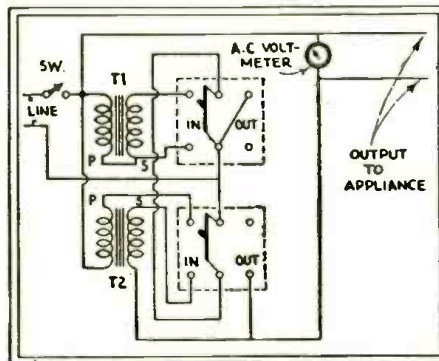

Mr. Halterman is vexed by a very annoying variation in his A. C. line-voltage. Here is how he overcomes the difficulty.

The transformers are taken from discarded "A" eliminators and deliver about 12 volts, with 90 volts on the primary. The arrangement is of the "two-stage" type; and either one or both transformers may be cut in, as desired, with the D.P.D.T. switches. With both in use, the voltage is boosted from 90 to about 115; with both cut out, the voltage is the same at the output as at the input.

The correct connections to the secondaries are found quickly by experiment; if they are reversed, the voltage will be lowered. If so desired, to meet local conditions, reversing switches could be cut into the secondaries; and then the output could be boosted or lowered as desired.

JESSE W. HALFERMAN,  
Box 356, Ridgely, West Va.

## A WAVE-CHANGING SWITCH

Editor, RADIO-CRAFT:

A device which I find convenient for cutting down the number of plug-in coils is a small condenser, so connected across a

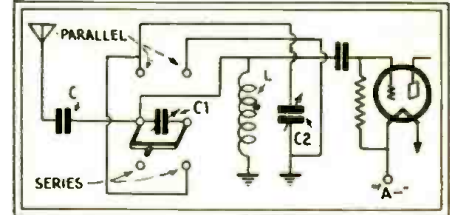

Mr. Fay uses this simple circuit to extend the tuning range of his coils; it is like the more elaborate method of wave-changing switches.

D.P.D.T. switch that it may be thrown either in series or parallel with the secondary tuning condenser. I am using a Pilot .00015, cut down to three rotor and two stator plates, and double-spaced; giving me approximately .00008 capacity. Across the D.P.D.T. switch, I have a small Hammarlund .00007 equalizer. The switch is a Carter jack-type, mounted on the panel for convenience and to reduce the length of the leads. In this way, I have a very small variable capacity for the lower wavelengths, and a higher one for the higher wavelengths.

LOUIS E. FAY, JR.,  
Auto Route West, Roswell, N. Y.

## ODD TUNING COILS

Editor, RADIO-CRAFT:

With the type of transformer I use, which departs considerably from the standard method, the set is equally sensitive from 200 to 545 meters; it is stable and hand capacity is practically eliminated on the 85-meter phone band; and shielding is required on neither 85 meters or the broadcast band.

This circuit was suggested by holding one turn of wire in the field of a radio-frequency transformer. The ends of the wire are connected, forming a complete circle; this turn is placed parallel to the transformer winding. One turn of wire on a transformer which is oscillating will reduce oscillation; however, the volume is reduced considerably. If the turn is broken and a .0005-mf. condenser inserted, the effect is reduced by approximately fifty per cent. Placing the turn of wire at right

(Continued on page 186)

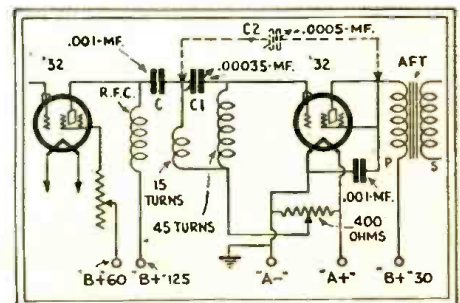

Mr. Coyner tries this experiment to stabilize his set, as described in the text. A previous method is indicated by the capacity C2.



# Rome and London come in like locals

JUST AS CLEAR—JUST AS LOUD

## SCOTT ALL-WAVE

A TRULY international receiver has been the desire of radio enthusiasts for years, and the hope of engineers since radio began. And what listener hasn't wished for a receiver that would bring him—not only the whole of North America—but the major stations on the other continents as well, and as easily? 1931 sees the perfected realization of all such dreams, in the new and genuinely excellent Scott ALL-WAVE Receiver.

The new receiver tunes from 15 to 550 meters. Actually—without exaggeration—it brings in Rome, London and many other foreign stations below 200 meters, just as clearly and with the same volume as a local broadcast. Grand Opera—the *real* Grand Opera, comes in direct from Rome to afford Scott listeners the musical thrill of a lifetime. And Big Ben, tolling off the hours in the House of Parliament in London, sounds as though it were right over head. Such reception is a REGULAR, DAILY event in homes equipped with the new Scott All-Wave Receiver.

### New Standards for Short Wave Reception

The performance of the Scott All-Wave below 200 meters is not to be confused with the unsatisfactory short wave reception of the past. There are no sharp edges—no irritating squawks—no mushiness or other disturbing receiver noises to take from the thrill of listening to the other side of the world. The short wave broadcasters unroll their music, voice and song thru the Scott All-Wave, with the same liquid smoothness as those within the 200-550 meter band.

### Credit goes to new kind of Intermediate Amplifier

The truly amazing performance—the unlimited range—the actual 10 kilocycle selectivity—all are due to the new type intermediate frequency amplification employed in this receiver. Never before thought of—never before attempted—this system of amplification accomplishes exactly what superheterodyne engineers have sought to achieve, ever since the advent of this admittedly superior receiving circuit.

### GIVES A NEW MEANING TO "TONE"

The tonal reproduction of the Scott All-Wave is equally as refreshing as its sensitivity and selectivity. From a whisper to concert volume, every note—every delicate shading is faithfully reproduced. The push-pull audio amplifier employed gives results impossible to otherwise obtain.

### MAIL NOW

Scott Transformer Co. C-9  
4450 Ravenswood Ave., Chicago  
Send me full details of the new Scott All-Wave Superheterodyne. I am a Dealer  Set Builder  Service Man  Radio Fan

Name.....  
Street.....  
Town.....State.....

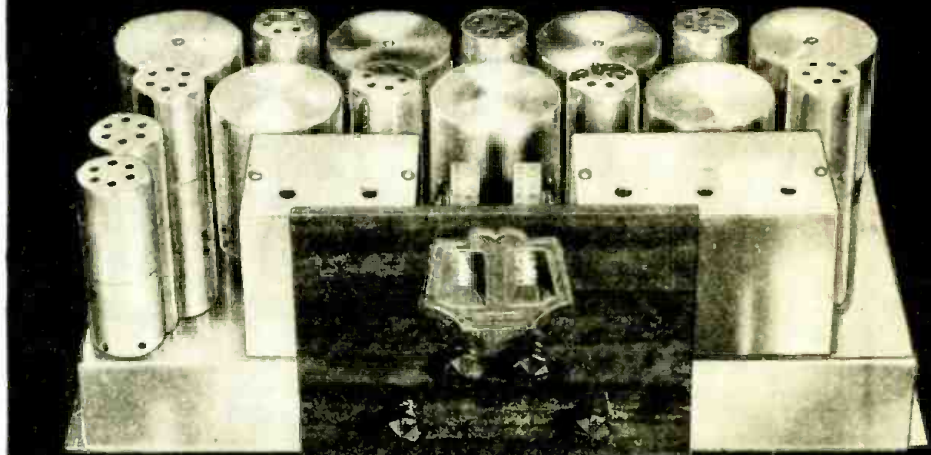

## SUPERHETERODYNE

### 5-YEAR GUARANTEE

To simply say that we believe the new Scott All-Wave to be the finest receiver ever built, does not

suffice to express our confidence in the engineering and quality construction that makes Scott performance possible. So—we guarantee each Scott All-Wave for five years and agree to replace any part—free of charge—that fails to give perfect service within that time.

### Make the SCOTT ALL-WAVE Prove Itself to You

Decide right now to have the ultimate in radio. Plug the new Scott All-Wave into a base board socket in your own home. Tune in Rome—tune in London—tune in Chelmsford—listen to Sydney, Australia—to Buenos Aires—to Bogota, Colombia—enjoy short wave foreign stations to your heart's content. Then step thru the broadcast band for the domestic stations. You'll find them all on dial, and all with far more volume than you can ever use. The price of the new Scott All-Wave is amazingly low. Write for full particulars at once.

**SCOTT TRANSFORMER CO.**  
4450 Ravenswood Avenue ~ Chicago, Illinois



# Radio-Craft's Information Bureau

**SPECIAL NOTICE TO CORRESPONDENTS:** Ask as many questions as you like, but please observe these rules:

Furnish sufficient information, and draw a careful diagram when needed, to explain your meaning; use only one side of the paper. List each question.

Those questions which are found to represent the greatest general interest will be published here, to the extent that space permits. At least five weeks must elapse between the receipt of a question and the appearance of its answer here.

Replies, magazines, etc., cannot be sent C. O. D.

Inquiries can be answered by mail only when accompanied by 25 cents (stamps) for each separate question. Other inquiries should be marked "For Publication," to avoid misunderstanding.

## RADIOLA S-W RECEIVER—CAPACITY BRIDGE

(131) Mr. L. A. Scott, Port Antonio, Jamaica, B.W.I.

(Q.1) I have on hand a Radiola "Model AR-1145" short-wave receiver. The instrument is not functioning as it formerly did; and I would like to have you show in RADIO-CRAFT its schematic circuit, and any additional data that may be available.

(A.1) The schematic circuit of this 4-tube battery-model short-wave Radiola receiver is shown in Fig. Q.131, together with all available constants. The tube (average) characteristics are as follows: filament potentials, V1, 3.2 volts; V2, V3, V4, 5 volts. Plate potentials: V1, V4, 130 volts; V2, 30 to 60 volts (depending upon the position of the volume control); V3, 65 volts. Control-grid potentials: V1, 1.5 volts; V2, zero; V3, 3 volts; V4, 9 volts. Screen-grid potentials: V1, 67.5 volts. Plate currents: V1, 3.5 ma; V2, 0.65- to 1.5-ma; V3, 1.1 ma; V4, 4 ma. Screen-grid current, V1, 0.5-ma.

Readings of V1 will vary with individual test instruments; those of a Weston "Model 537" test set being given above.

The color code of the 6-wire battery cable is as follows: Red, "B+135"; maroon, "B+67½"; black-green, "C-3"; black, green tracer, "C-9"; yellow, "A+" (6 volts); black, yellow tracer, "A-".

To the lug on the last is connected a green, red-tracer lead which terminates in a "B-" lug from which runs a short green, red-tracer lead which terminates in a "C+" lead.

The wavelength range of the standard "Model AR-1145" receiver is approximately 15 to 75 meters, covered by three coils; though two additional coils are available for the 200- to 545 meter range. The antenna may be to 25 to 100 feet long.

In lieu of the resistor R2, some models incorporate an R.F. choke coil. It is recommended that a 5-amp. fuse be placed between the yellow, positive filament lead and the battery.

Station interference may be reduced by using a short antenna, or connecting in series with the aerial a condenser of .00025-mf. capacity. In

Fig. B (Q.131)

Schematic circuit of a capacity bridge for measurements between 10 mmf. and 0.05-mf. The conventional representation of the circuit is Fig. A, below.

Fig. C (right)

Approximate graph obtained with a "straight-line-frequency" standard condenser, CS.

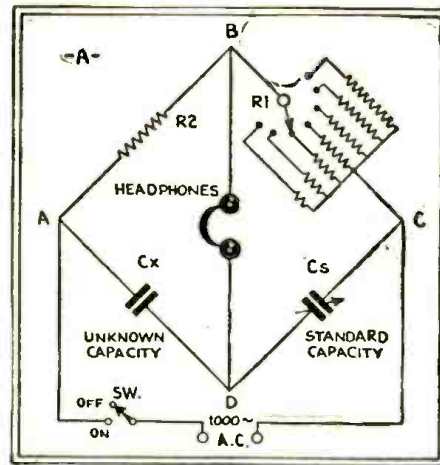
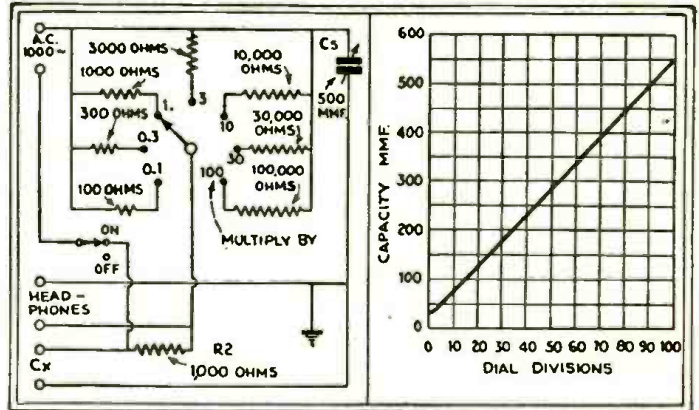

Fig. A (Q.131)

some instances, it may be necessary to use a wavetrap in the antenna lead. A supplementary volume control is a 2000 ohm variable resistor connected in series with the antenna.

(Q.2) Please show the circuit arrangement of a simple capacity bridge to use headphones and measure capacities less than one microfarad.

(A.2) The circuit arrangement of an excellent bridge of this type, developed by Mr. Beverly Dudley and described in QST, is shown in its elementary form in Fig. A; and in detail, in Fig. B. Its capacity range is approximately 10 mmf. to 0.05-mf. Its operating graph in position 1 of the selector switch is shown in Fig. C. However, this is only approximate, and the completed test instrument must be sent to a laboratory for calibration. (See also "Measuring Inductance and Capacity" in the June, 1931 issue of RADIO-CRAFT.)

## DATA ON SONORA RADIO RECEIVERS

(132) Mr. Alfred Pogany, Philadelphia, Pa.

(Q.1) What are the differences which distinguish Sonora "Model A-20," "44," "46" and "A-36?"

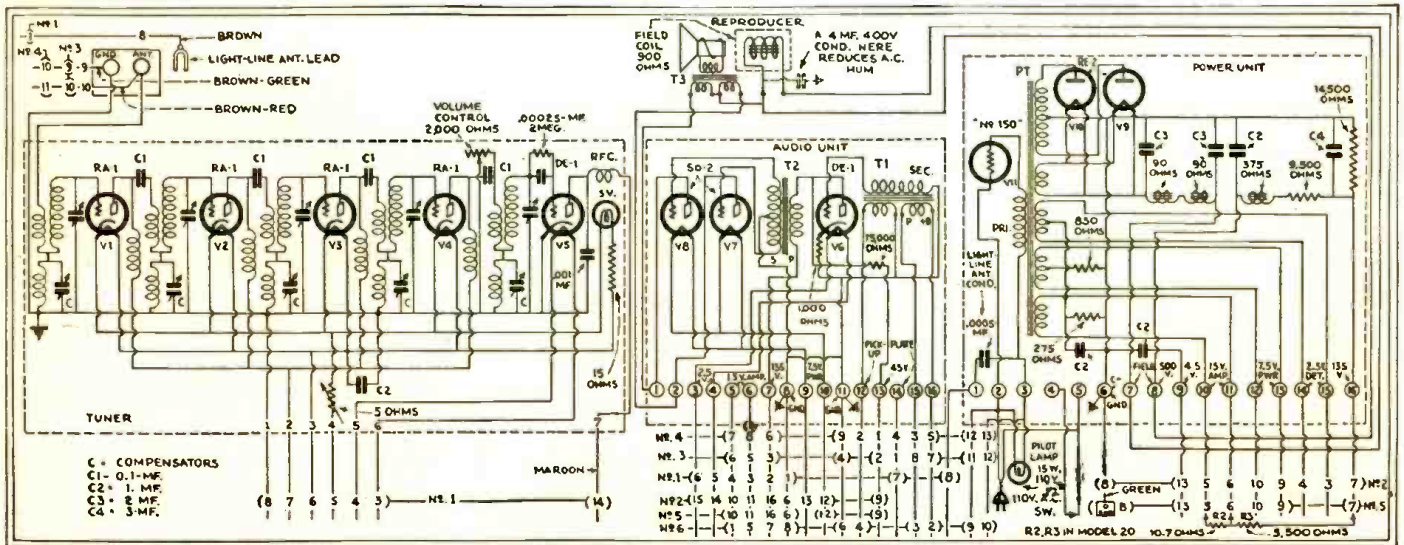

Fig. Q.132A

Fundamental arrangement of four Sonora receivers. For "Model A-30," "A-31," or "A-32," connect cables 1, 2, 3, between tuner, audio, and power units; "Model 40," cables 1, 2, 4, between tuner, audio, power, and phonograph (suitable also for the "Model 44" and "46," on page 148) units. Color code, audio unit (all models): 1 to 16, respectively; brown-red; brown; yellow; blk.-yellow; blk.; green; blue; maroon-blk.; maroon; blk.-blue; blue-blk.







## The Latest Radio Appliances

(Continued from page 141)

sharply tuned, and its output drops about eight decibels at a point about 5 kc. on either side of resonance. The "Type S" is more broadly resonant; and at 5 kc. off resonance it drops only about 0.3-db.; the gain, however, is greater than can be obtained from the "Type F." The "Type S" transformer is unshielded.

It is usual to use in a circuit design one "Type F" unit and one or more "Type S" units.

The "Type B" transformer is the most broadly resonant of all; it has still greater gain than the "Type S," but drops only 0.14-db. at 5 kc. off resonance. This unit is designed particularly for operation in Stenode circuits.

A special short-wave I. F. transformer, peaked at 450 kc., is also available.

These units are manufactured by the DeJur Amisco Corp., New York City.

### TRANSPARENT LIGHTNING ARRESTOR

THE special merit of the lightning arrestor illustrated in Fig. D lies in the use of clear glass; making it convenient to

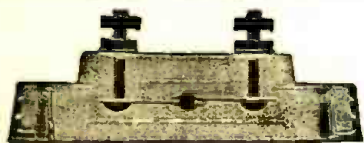

Fig. D

The "Vulcan" arrestor is of clear glass.

determine the condition of the arrestor merely by visual inspection.

Between its two springs is an element having a resistance of 600,000 ohms at low current and voltage densities. If the voltages across this resistor greatly increase, it becomes of low resistance, and by-passes this current to ground.

The manufacturers call attention to the fact that the Board of Underwriters specify a break-down potential of not more than 500 volts, and that this new "Vulcan" unit comes well within this rating with its break-down potential of 330 volts. It is of standard size.

Manufacturer, the Cornish Wire Co., Inc., New York City.

### AUTOMOTIVE VARIABLE-MU TUBE

LATEST in the line of automotive receiving tubes (cathode type, with 6.3-volt heater) previously available is a variable-mu tube, recently announced. This newcomer makes the series of tubes designed for automotive use just as complete, for the construction of a modern set, as the more standard A. C. tubes.

This tube, designed to reduce cross-talk, is technically described as of the "remote-cutoff screen-grid type." It is probable that, like its predecessors in the automotive line, it will be followed in a short time by tubes of similar characteristics but different make.

This tube, the "Type NY-65," is manufactured by National Union Radio Corp., New York City.

### SHOCK-ABSORBER WASHERS

IN Fig. E is illustrated a new tube protector, made of resilient material, with adhesive surfaces. When placed beneath the tube base, between tube and set, it serves to hold the tube in the socket; a convenience and safety measure in transportation.

In a measure, it serves also to reduce the tendency toward microphonic action, when a receiver is in operation.

These "Stiktube" socket washers are manufactured by Sampson Industries, Inc., St. Louis, Mo.

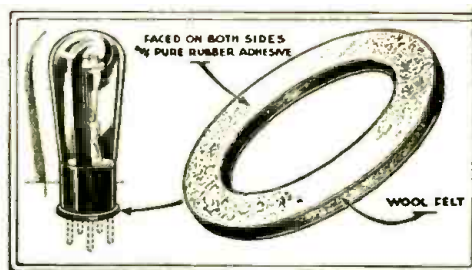

Fig. E

These shock-absorbers, resembling "bunion protectors," protect tubes in shipment, etc.

### "LABORATORY" RAPID WIRING KIT

CONNECTION cords of various lengths are a familiar sight in the radio workshop. Usually, they terminate in spring clips of convenient size; and, less commonly, these clips may be covered by soft-rubber sheaths which insulate and protect them. This has been the status of test leads, practically everywhere, until the advent of the kit illustrated in Fig. F.

These cords, of cotton-insulated, colored, stranded, copper wire, are available with numerous tips, such as spades, phone-tips, battery clips, and coupling terminals; each protected at the juncture of wire and tip by special soft rubber covers. These alter things, and offer a convenience and speed in making test connections that is hard to realize; accustomed as we are to more laborious, antique methods.

Three cable lengths are available, 9 in., 18 in., and 36 in., and the assortment supplies a lead for each requirement.

When it is desirable to make a coupling, a little double-end coupling pin is inserted into one of the sockets, which is thus converted into a plug; this plug, in turn, will attach to a junction block. Eight of these sets are supplied with a neat instrument-finish rack; the junction blocks may be used on this rack, or placed conveniently on the table. These blocks are made up with one binding post on the top, and four sockets;

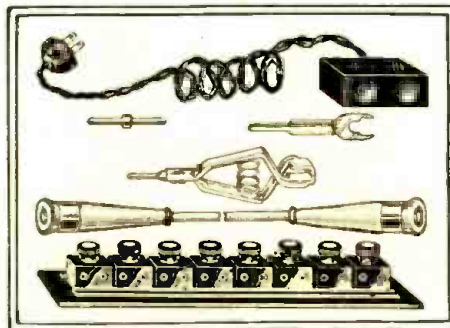

Fig. F

Typical terminals and receptacles of the type available in the new "Laboratory Rapid Wiring Kit" for quick connections.

all five terminals being common. The sockets accommodate coupling pins and cables; the binding posts will take spade terminals with coupling tips. Alternatively, wires may be placed under the large bakelite posts, which are tipped by celluloid discs on which voltages, etc., may be indicated in pencil (erasable when desired).

A "service" cord is supplied, for connection to the 110-volt A. C. line outlet; one end has a plug, and the other a two-terminal coupling receptacle, with no exposed connections.

There is included a test rack, equipped with spring clips, for speedy testing of condensers, resistors, etc.; each clip has a pin terminal, upon which test leads may be fastened.

In addition to the above, there are available accessories such as push-buttons for "make" and for "break." One pair of short, and one of long test prongs are included; the former are convenient for taking meter readings in various portions of a circuit, and the latter for making contact in tube sockets.

Although each item is available separately, they are most conveniently purchased as a kit, as follows: twelve 9-inch, twelve 18-inch and twelve 36-inch test cables; 36 coupling terminals; 36 spade terminals; 12 clip terminals; 8 junction blocks; 1 junction rack; 1 test rack; and 1 service cord. All are packed in a wooden case.

The "Laboratory Rapid Wiring Kit" is a development of Howard B. Jones, Chicago, Ill.

### Favorite Testing Equipment

(Continued from page 147)

men to work, at either end of the panel, without interference.

The row of meters is as follows, from the left: 0-50-250 volts, D. C.; 0-10 volts, A. C.; 0-100 galvanometer, for condenser alignment; 0-10,000 ohmmeter; 0-500 volts, D. C.; 0-150 D. C. milliammeter; for electrolytic condenser tests; 0-4-8-150 volts A. C.; 0-80 D. C. milliammeter for speaker tests; 0-10,000 ohmmeter; 0-250 volts A. C.; 0-50-250 D. C. voltmeter, a high-resistance instrument calibrated for 0-10-megohm high-resistance measurements. Numerous pin jacks supply all the necessary connections.

### Service Men's Notebooks

(Continued from page 153)

a deep breath and blow steadily into the rubber tube, directing the candle flame into a sharp point hot enough to melt solder.

For re-soldering, rosin-core solder may be used; but the writer prefers "Solderall" as this can be squeezed out on the job, leaving the hands free to hold the candle and the "blower."

### ULTRA-RESISTORS IN DEMAND

FOR the measurement of small currents, extremely high resistors are needed to create voltages across the vacuum-tube measuring instruments. Probably the record was reached, however, when the astronomers who were measuring with thermocouples the radiation from the stars called for 10,000-megohm resistors. These were finally made up, in metallized form, by the International Resistance Co.



# The A.C. Pentode Portable

(Continued from page 157)

Then mount the tuning condenser, coil and switch on the side of the case, as shown; after which the baseboard with the mounted and wired parts may be inserted, and the few connections between the coil, condenser and switch completed.

The aerial and ground binding posts are also mounted on the side of the case. A single wire, 25-50 feet long dropped out of the window, will serve as an aerial. A ground connection is usually not necessary; for the light-line serves this purpose also.

The completed set makes an ideal portable outfit. It is easily carried, and can be connected up in a few minutes. Tuning is simple, for there is only one tuning condenser and the regeneration control to regulate. While the receiver is somewhat broad in its tuning, it nevertheless has great entertainment value and will be found to be a very useful companion.

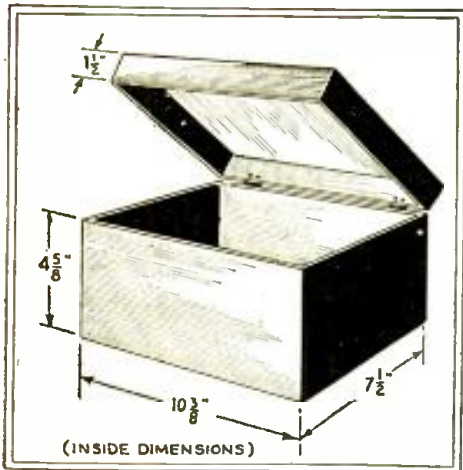

Fig. 6

An opening 5 1/2 inches in diameter is cut through the cover of the case, to give an output for the speaker, and covered with a grille cloth.

### Experimental Uses

Perhaps it may not be obvious to many constructors that this receiver will operate in many localities without the use of a regular antenna installation, but using instead the antenna effect of the power line. To try this connection, connect a .01-mf. fixed condenser from the antenna binding post to one side or the other of the light-line.

Another interesting observation is the adaptability of the instrument as an ordinary A.F. amplifier to operate in conjunction with a microphone or a phonograph pick-up; when detector V1 becomes a first stage of A.F. amplification.

The manner of coupling a microphone or a phonograph pick-up to the grid circuit of a grid-leak-and-condenser detector is discussed in an article on home recording in this issue.

Spring-motor phonographs often comprise part of the paraphernalia of the vacationist who is pleasure bent. And, by substituting an electromagnetic pick-up for the mechanical unit (sound-arm and diaphragm in these musical instruments) and connecting it to the A.C. Pentode Portable, phonograph recordings may be reproduced with volume and tone quality far surpassing the ordinary mechanical phonograph.

- List of Parts for the A.C. Pentode Portable**
- One Insuline "Midget Companion" carrying case, 6 1/4 x 7 1/2 x 10 3/8 inches (inside);
  - One Utah "Midget" dynamic speaker, with 2,500-ohm field winding; output transformer and UX-base connecting plug;
  - One Gen-Win three-circuit tuner, for .00035-mf. condenser (I, I.1, I.2);
  - One Hammarlund "Midget" .00035-mf. variable condenser (C1);
  - One Hammarlund A.F. transformer, secondary only used (I.3);
  - Three Aerovox fixed condensers: one .00025-mf. (C2); one .0005-mf. (C3); one .01-mf. (C4);
  - Two Flechtheim filter condensers: one 2-mf. (C5); one 1-mf. (C9);
  - Three Concourse 4-mf. electrolytic condensers (C6, C7, C8);
  - Two International grid-leak resistors: one 2-meg. (R); one 1/2-meg. (R2);
  - One International 250,000-ohm plate resistor, (R1);
  - Three Electrad wire-wound voltage-divider resistors: two 12,000-ohm (R3, R4); one 5000-ohm (R5);
  - One Electrad wire-wound 400-ohm "C"-bias resistor (R6);
  - Four Na-Ald sockets; two UY (V1, V2); two UX (V3 and speaker receptacle);
  - One Earl Power transformer, with 2.5-, 5- and 100-volt center-tapped secondaries (PT);
  - One Cutler-Hammer power toggle switch (Sw);
  - Two binding posts ("Ant." and "Gnd");
  - One baseboard, 1/4-inch thick, to fit inside case.

The constructor may use any coil suited to the regenerative circuit which he decides to adopt (as explained above) and to the value of the condenser which he uses. Data for the construction of broadcast coils have been given in previous issues of RADIO-CRAFT; the unit used here has a tickler of 32 turns of No. 26 D.C.C. wire on a 1 1/4-inch form, inside a 2-inch form on which are wound a secondary of 63 turns and a primary (not used in this hookup) of 12 turns of the same wire.

The Editor will be glad to hear the experiences of the readers of RADIO-CRAFT who build the Pentode Portable; especially along the lines of distant reception, since this circuit is designed for high sensitivity, as well as large output.

### Service Oscillators

(Continued from page 147)

To calibrate this oscillator tune a good receiver to a broadcast station of a known frequency; and then turn the dial of your oscillator to the position which the loudest signal is obtained in the receiver.

The writer has made another oscillator more compact than the one pictured. Instead of the large condenser, a midget of the same capacity is used. The coil is wound of No. 28 D.C.C. wire, using 109 turns on a 1 1/4-inch tube. The 25-watt bulb is long and slender (Fig. 4A); six and one eighth inches high with the base. The whole job is 6 1/4 inches high, 4 1/2 inches deep and 5 inches long.

The same loose-leaf plan as before—the same valuable data—but handier and more complete.

Servicemen in every State in the Union rely on the I. R. C. Resistor Guide.

And now in its more compact form it is more valuable than ever. Shows 200 circuits with all the resistor data you need to know—the types and values to use everywhere. A remarkable time saver.

**FREE with Metallized Resistors**

With the purchase of any 10 Metallized Resistors you receive the Replacement Guide free—or it may be bought in its new form for \$1.

Loose-leaf sheets sent periodically without charge, keep it always up to date. Mail the coupon today—take the jinx out of repair work!

Published by  
INTERNATIONAL RESISTANCE CO.  
Philadelphia and Toronto

Makers of

**I R C**

*Metallized*  
**RESISTORS**

All orders for Resistors referred to Jobbers

INTERNATIONAL RESISTANCE CO., C-9  
2006 Chestnut St., Philadelphia

Gentlemen: (Check offer you are interested in)  
 I enclose \$1.00 for Replacement Guide.  
 Please send price list of Metallized Resistors. I wish to purchase assortment of ten, which will entitle me to Replacement Guide Free.

NAME .....  
ADDRESS .....  
CITY ..... STATE .....

# Announcing the *NEW* 1932

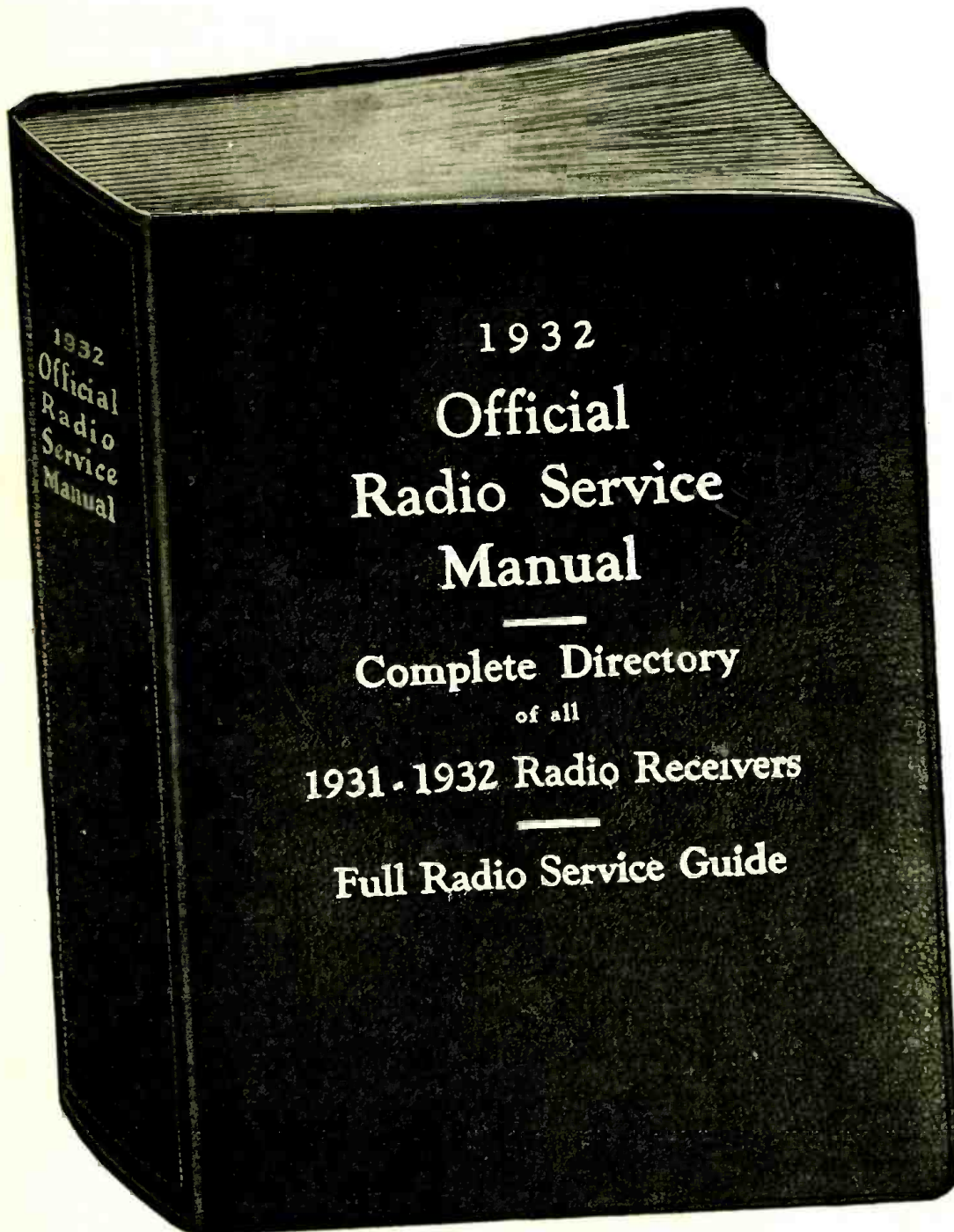

Over 1000 Pages.

Over 2,000 Diagrams,  
Hook-ups, Charts and  
Illustrations.

Flexible Looseleaf  
Binder.

Size 9" x 12".

Complete Directory of  
all 1931-1932 Radio  
Receivers.

Full Radio Service  
Guide.

For Radio Service Men,  
Manufacturers, Jobbers,  
Dealers and Amateurs.

HUGO GERNSBACK,  
Editor

C. H. W. Nason,  
Managing Editor

Clyde Fitch,  
Managing Editor

NEW MATERIAL  
THROUGHOUT

NO REPRINTS

ALL ORIGINAL  
MATERIAL

ONE MONTH

**ONLY**

AT THIS PRICE

**\$4.00**  
A COPY

After August 31st, the  
Manual will sell for  
\$5.00 a copy.



# Official RADIO Service Manual

## WITH FREE Supplements

mailed to Manual Owners every 60 days—

**T**HE progressive Service Man finds it essential to keep right up-to-the minute with new sets as they are placed on the market, particularly from the servicing viewpoint. It is required of him to repair accurately any receiver, regardless of model or manufacture. To facilitate the work of the Service Man, the NEW 1932 OFFICIAL RADIO SERVICE MANUAL will give every diagram or circuit that

will ever be needed; and in addition, it will show him how to service properly and in a much shorter time, a receiver of any make and construction.

Over 30,000 copies of the first Manual were bought by men in every branch of the radio industry. **THE NEW 1932 MANUAL WILL BE BOUGHT BY EVERYONE IN THE RADIO FIELD.**

### The Contents of the 1932 Official Radio Service Manual

**N  
E  
W  
!**

A step-by-step analysis of a typical radio receiver, which has all the features and all possible combinations of modern radio practice; all this has been included in a single design for the instruction of the service technician. This chapter contains a great many pages, fully illustrated by many diagrams to make every point plain. It is the most valuable contribution to the radio service field that has been made, and nothing like it has ever appeared in print.

A complete Manual on the operation of all types of vacuum tubes, whether new, standard or obsolete. No question that you could possibly ask in connection with the operation or usage of vacuum tubes has been omitted. A discussion of the operating voltages for various types of tubes, and what occurs when they are under- or over-loaded, is given. Completely illustrated with charts and diagrams.

Complete service data covering all modern radio receivers which the technician is likely to encounter in his work, together with specialized service notes covering the peculiarities of the individual receivers. A special chapter is devoted to some of the older receivers which were not included in the first Manual.

Practically all data of an exclusive resume on the operation of the new Pentode and Variable Mu tubes, as used in the latest receivers, with complete information and their characteristics.

A complete discussion of the superheterodyne and its inherent peculiarities with detailed instruction on the alignment of the oscillator and intermediate-frequency circuits. Complete trouble-hunting information on the superhetero-

dyne, leaving no important detail untouched. Also a special chapter on tools used on superheterodyne circuits.

A Manual on the full operation of the various set testers and analyzers now on the market. Data on the construction of serviceable testing equipment; tube voltmeters, output meters, oscillators, aligning tools, etc.

A special large section is devoted to Midget receivers. This chapter contains the difficult problems that are met with in these type receivers—how to service them most rationally—time-saving short-cuts—where to look first for trouble; and, of course, a sub-section devoted to the circuit diagrams of the most important midget sets on the market.

Practically all of the schematic diagrams and hook-ups are now augmented by full color codings, and by the inclusion of the complete circuit and coding arrangements of the individual parts, according to RMA specifications. This innovation alone is of tremendous importance to the Service Man, and will save the cost of the book many times over.

Complete Service Manual on the commercial aircraft equipment now being supplied for use on commercial airways; in order that the technician may be put in a position of increasing his income by the servicing of receivers on planes passing through the local airport.

All available new data on the commercial short-wave receivers and converters, including hook-ups, diagrams, and servicing data on such receivers and converters. Many 1932 receivers are now equipped with shortwave tuners, or converters, and it is important to the Service

Man and technician to know this phase of the art, as it is increasing year by year. The problems of connecting exterior converters and a description of them, including hook-ups of such converters, is included in this chapter.

A complete and exhaustive chapter featuring circuits and service data on the more important public-address systems, and on talking motion-picture equipment. This is a phase of radio which the Service Man often overlooks; and yet it is an important source of his income. A large amount of material shown here is entirely new.

A complete section giving dozens of tables of data on various phases of radio servicing. The material shown in this chapter is all "meat," and is of a practical nature; this information, alone, is worth the entire price of the book.

Complete tables of standardized color codings for resistors. These tables are most important, and will be referred to daily by thousands and thousands of radio Service Men all over the country.

#### IN ADDITION—

there are over 2,000 complete diagrams, hook-ups, and special reference data on commercial receivers. In many cases, the book contains special information on the servicing of such receivers as recommended by the manufacturer. In our last year's Manual we showed mainly the receiver diagrams themselves, and we included little servicing data. In the 1932 Manual, we are giving a tremendous amount of servicing data for many of the important receivers, which is also a distinct and important departure.

#### Additional Features—

Supplements to the New Manual will be issued every 60 days FREE OF CHARGE.

FREE Question and Answer Service to every owner of the Manual.

Blank pages for recording notes, diagrams or sketches are included, and are transferable to any part of the book.

The New Manual will contain three times as many pages and twice as many diagrams and circuits as the first Manual.

**THERE WILL BE NO CUT PRICE ON THE 1932 MANUAL ANYWHERE.** After it is published, the price becomes \$5.00.

#### NOTE!

Last year the Supplements were mailed to subscribers on a regular subscription basis at the rate of \$3.50. This cost was in addition to the price of \$3.50 for the Manual. WITH THE 1932 OFFICIAL RADIO SERVICE MANUAL YOU WILL RECEIVE THE SUPPLEMENTS EVERY 60 DAYS WITHOUT ANY ADDITIONAL CHARGE. This is the most sensational offer given by any publisher at any time.

#### Mail Coupon TODAY!

GERNSBACK PUBLICATIONS, Inc. RC-9  
96-98 Park Place, New York, N. Y.

I enclose herewith remittance of \$4.00, check or money order preferred, for which you are to send me the NEW 1932 OFFICIAL RADIO SERVICE MANUAL at the pre-publication price. I understand that all the Additional Features and the New material will be included in the Manual and Supplements.

Name \_\_\_\_\_

Address \_\_\_\_\_

City \_\_\_\_\_ State \_\_\_\_\_

# SKINDERVIKEN



**The Most Sensitive Microphone Button**  
(ACTUAL SIZE NOT BIGGER THAN A QUARTER)

You can easily make a highly sensitive detectophone by using a Skinderviken Transmitter Button to collect the sound waves. You can build your own outfit without buying expensive equipment. Think of the fun you can have with such an instrument.

You can install an outfit in your home and hear the conversation being held all over the house.

Full directions for connecting up the button for use as a detectophone are given in our 12-page booklet.

These wonderful little SKINDERVIKEN microphone buttons may be used for hundreds of uses, such as:

- |  |   |
|--|---|
| RADIO AMPLIFIER<br>DETECTOPHONE<br>STETHOSCOPE<br>MICROPHONE | PHONOGRAPH AMPLIFIER<br>TELEPHONE AMPLIFIER<br>LOUD SPEAKER AMPLIFIER<br>CRYSTAL SET AMPLIFIER<br>HOME RECORDING OUTFIT, ETC. |
|--|---|

**95c EACH**      Two for **\$1.75**  
**12-PAGE INSTRUCTION BOOKLET**  
containing suggestions and diagrams for innumerable uses, furnished with each unit.

EVERY AMATEUR SHOULD HAVE TWO OR THREE OF THESE AMPLIFIERS IN HIS LABORATORY

WE PAY \$5.00 IN CASH for every new use developed for this unit and accepted and published by us.

## SEND NO MONEY

When the postman delivers your order you pay him for whatever you have ordered, plus a few cents postage.

(Canada and Foreign: cash with orders)

PRESS GUILD, Inc.,      RC-931  
16 Murray St., New York, N. Y.

Please mail me at once as many of the following items as I have indicated.

...Skinderviken Transmitter Units at 95c. for 1; \$1.75 for 2; \$2.50 for 3; \$3.20 for 4.

When delivered I will pay the postman the cost of the items specified plus postage.

Name .....

Address .....

City..... State.....



**\$5,000 WILL BE PAID TO ANYONE WHO PROVES THAT THIS IS NOT THE ACTUAL PHOTO OF MYSELF showing my superb physique and how the Ross System has increased my own height to 6 ft. 3 3/4 inches. Hundreds of Testimonials. Clients up to 45 years old gain from 1 to 6 inches in a few weeks!!**



First in 1907  
First To-day

No Appliances—No Drugs—No Dieting. ROSS SYSTEM NEVER FAILS. Fee Ten Dollars Complete. Convincing Testimony and Particulars 5 cents stamps. Allow time for return mails across the Atlantic. G. MALCOLM ROSS, Height Specialist, Scarborough, England. (P. O. Box 15).

### A SPECIAL OFFER TO NEW READERS

— Eight months subscription to RADIO-CRAFT for \$1.00. Send remittance to RADIO-CRAFT, 98 Park Place, New York, N. Y.

# Up and Down the Waves with the Scott "All-Wave" Superheterodyne

(Continued from page 158)

a decided pleasure, and the time passed so rapidly that it was midnight before I realized the hour.

### Strong "DX" Reception

I decided to have a try for "DX" again. This time I had much more success; for the distant stations which literally "poured in" were much further away than those heard earlier. Unfortunately, man-made static had become very annoying in my locality, and it was found impossible to listen with the volume control turned up more than two-fifths of the way. For this reason, the receiver was not able to show that night what it could do when pushed to its limit. Despite this handicap, the performance was quite remarkable for summer conditions. The reception log, it will be observed, contains stations in Texas, Colorado and Mexico.

At this point, it might be well to mention that this station log contains only those stations which were listened to long enough to hear their call letters. If all the stations heard had been logged the list would be about double its present length.

The receiver was not tested after one o'clock in the morning; so that no opportunity was had for picking up any far western stations; but the tests were so satisfactory that I am convinced that European stations can be heard on the broadcast band during the winter.

Daylight tests with the receiver showed that stations up to 300 miles distant can be easily picked up without advancing the volume control beyond the half-way mark.

### Short-Wave Reception

On the short-waves, the receiver showed up exceedingly well. Tone quality still remained very fine—an unusual feature for a short-wave set. The annoying rushing noise, familiar to users of regenerative short-wave outfits, was noticeably absent.

The Scott set was checked on the short waves by comparison with the reception from a four-tube receiver using one tuned screen grid (21) stage of R.F. amplification, a regenerative (27) detector, and a two-stage audio amplifier (also 27s). During previous tests with the four-tube outfit, European stations had been coming in for over a month with only fair strength, with but few exceptions. Station G5SW at Chelmsford, England, relaying the national programme from the London studios of the British Broadcasting Company on 25.53 meters (11,750 kc.), was first tuned in. On the superheterodyne, the programme was as loud, with the volume control advanced only a quarter of the way, as it was on the four-tube set with its regeneration control advanced to maximum. Because of the absence of regeneration in the super, its quality was much better than that of the regenerative set.

Once again that bngbear of radio, man-made static, interfered. On this occasion it was augmented by the interference from the ignition system of automobiles passing in the street. This noise made it impossible to test the set with the volume control advanced any further than the halfway mark.

Other stations heard with good volume on the short waves included 12RO at Rome, Italy; FYA, the new colonial government short-wave broadcaster at Pontoise, France; the German broadcasting company's station at Konigswusterhausen; both ends of the transatlantic phone system; (London-New York); a Dutch phone station communicating with the island of Java; and some North American broadcasters — W8XK, Pittsburgh; W2XAF, Schenectady; W9XF, Chicago; W9XAA, Chicago; W8XAL, Cincinnati; W2XE, New York; W3XAL, Bound Brook, N. J.; and VE9CL, Winnipeg, Canada.

The selectivity was far better than anything I have ever tried on the short waves. With the four-tube set W8XK on 25.24 meters was overlapping 12RO on 25.42 meters, and also G5SW. With the "super," there was no trace of interference on either of these stations.

Tuning on all waves was very easy and lacked that "critical" action found in most all-wave sets.

### Convenient Wave-Changing

The manufacturer supplies, as part of the regular equipment for the Scott receiver, two sets of plug-in coils for the short and broadcast waves (12 coils in all). These are very easy to insert and remove. On the coils from 15 to 38 meters, the clips to the control-grid caps of the first R.F. and first detector tubes are attached to two red-covered wires. The antenna is connected directly to one of these clips and through an R.F. choke to ground.

For the waves from 38 to 184 meters, the control grid connections are red to the first R.F., and black to the first detector. For the broadcast coils (200-550 meters) the connections are black, to both tubes. The antenna, for this work, is connected to the regular antenna post at the rear of the chassis.

The Scott "short-wave station finder" is a neat little gadget, supplied with the set, to determine the dial setting for any given wavelength. One merely sets the indicators to the wave desired and—presto—above it appears the coil number for that wave, and also the dial setting of the receiver. It is then a simple matter to insert the designated coils in the receiver, and set the dials according to the station finder's instruction. This ingenious device saves much time and bother.

## The Open Forum

(Continued from page 154)

manufacturers take the same attitude, and this goes for them too.)

Why not devote this valuable space to other makers who furnish their diagrams with all the necessary data to speed up service work; which avoids the loss of less valuable time in probing an obscure receiver, and therefore results in speedier work and more benefit for the independent Service Man? How about it, fellows? Let's hear from you.



Here's success to RADIO-CRAFT till waves are shortened to a millionth of a meter.

JULIUS DEMMA,  
3609 East 114th St., Cleveland, Ohio.

**"USE EVERY MAN ACCORDING TO HIS DESERT—"**

Editor, RADIO-CRAFT:

I can't begin to tell you how I've tried to absorb some fellows' yarns about servicing. I am a modest little Service Man myself, and fed up with such contributions as that by Mr. F. G. Poli of Detroit, in the February "Open Forum." Let me quote: "A Radiola '44' which would only bring in a few strong locals, beside excess oscillations, had been attended previously by two 'Service Men.' Since some of these do not know where to find the neutralizing condensers on these models—"

Before reading this article, I never knew of the RCA "44," in any condition, oscillating from an open antenna lead. He claims that the set had been attended by two "Service Men," emphasizing "Service Men;" evidently the same can be applied to him.

On the same page (461) appears an article by Mr. J. Pristash: "You cannot injure the chokes and condensers; the temperature cannot rise high enough to burn them, because of the low melting point." Evidently Mr. Pristash doesn't know that heat in any form does injure condensers and that replacement cartridges can be bought for less than the time required to salvage.

Again, let me call your attention to Mr. Dale Pollack; on page 464 he goes into elaborate detail about some forms of oscillators that no Service Man ever used:

"Unfortunately, however, most oscillators used at present comprise the elements of a young broadcast transmitter. Another type of oscillator employs a buzzer . . . must be very carefully packed in a cotton-filled box—" Lousy!

Why the unnecessary articles on stuff like this, when Service Men have been using his new system with any and all kinds of tubes for ages now?

And then he drops a bomb on our enthusiasm, after relating its superior qualities along with portability: "Apply the proper voltages either from the power supply or from batteries (one cell of a storage battery may be used for the '24 filament)—"

He says, carry a storage cell around to light the '24 tube. Isn't that neat and compact and portable—oooy?

No, we are out for scalps now and finding on page 484 Mr. A. M. Tinker of Chicago: "I attached two wires to the secondary of the transformer." Who conceived connecting a magnetic speaker to the secondary of the output transformer?

"The choke connection to the primary can be used in this way only if some method of isolating the speaker from the D.C. plate potential is used."

And the fellow is keeping me in suspense, wondering how he could be so cruel as not to let us know how to keep the D.C. potential out of the speaker. Alas! A lost art, I betcha.

Don't get me wrong, Mr. Editor. I'm for the fellow who has news or information to impart; but I do think that there should

be a more careful study made of some of these editorials by some of these young service engineers who suddenly find that the older Service Men are only fakers, and that they were educated just in time to save the race.

Here's to a better magazine for the Service Man.

O. E. FAULKNER,  
426 W. Block, Eldorado, Arkansas.

(The prophet Job, we have read, was remarkably meek after he had been addressed out of a whirlwind by Omniscience. We can only imitate his humility with the mental reservation that the younger technicians will some day be elders reproving a presumptuous third generation.—Editor.)

**ATTENTION, MANUFACTURERS**

Editor, RADIO-CRAFT:

I think it would be a good idea for the radio manufacturers to get together and compel all their dealers to have a competent Service Man and make him pass an examination. That is the only way I think it can be done. A lot of dealers can get men to do the work for \$15.00 a week who get by some way and, as long as they can get men to do it for that, they do not care whether the public gets a fair deal or not. I could give many instances of the cases I have come in contact with, as an independent Service Man; and I think it is fine action was taken to do away with the hit-and-miss variety and have them eliminated altogether. I charge \$1.00 an hour and will not do it for less; I believe the 50-cents-an-hour work is dearest in the end. Also, I am no flying Service Man; I would like to see the fast men and see what they do. Yours for better service to the public.

HAROLD B. AULENBACH,  
91 Augusta St., Hamilton, Canada.

**NOISE IN THE POWER TRANSFORMER**

Editor, RADIO-CRAFT:

I get RADIO-CRAFT every month and read all of it, even most of the advertisements. I have been helped out of a hole many a time by some article covering a certain ailment of a radio and here is one that I would like to pass on to some other Service Man who may profit by my experience.

I was called to see about a Westinghouse "WR-5" super. The complaint was noise. I couldn't find any local cause for the noise, so I took the set home with me. Everything tested OK and I was just about to acknowledge defeat when, upon turning on my own set, I picked up the same noise (the "WR5" was still turned on). I cut out each unit as I came to it till I reached the rectifier tube. When I touched one plate prong with a test prod the noise would be heard. I then cut the wires loose from the plate contacts in the socket; the noise increased when one was removed, but couldn't be heard when the other was removed. I decided then that one side of the high-voltage winding was arcing, either to the case or to the core; replacing the power transformer stopped the noise. Having another receiver in operation was what found the trouble for me.

(Unsigned),  
220 North Third St., Gadsden, Alabama.

**Make Depression Pay!**

Take advantage of the present demand for repair of old receivers! Build strongly for the future, and increase your business by giving GUARANTEED REPAIRS.

You can do this safely by using Radio's Finest Parts—

**POLYMET PRODUCTS**

Standard of the Industry

FOR FILTER BLOCK REPAIRS THE POLYMET KIT OF 25 UNCASED CONDENSER SECTIONS illustrated below—is the most useful Kit ever assembled for service work. Many capacities and sizes, all in strict accordance with R.M.A. ratings.

Mail the Coupon for special low-price introductory offer. It will also bring you the new 1931 Polymet Parts Catalog, containing many service helps.



POLYMET MFG. CORP.  
829 East 134th St.  
New York City.

Send me your sensationally low-priced introductory offer on the Polymet Condenser Repair Kit. Also include the new 1931 Polymet Radio Parts Catalog, without charge.

Name \_\_\_\_\_  
Address \_\_\_\_\_  
City \_\_\_\_\_  
State \_\_\_\_\_

- Mark Proper Square
- JOBBER
  - DEALER
  - SERVICE MAN
  - CUSTOM SET BUILDER

**AUTO RADIO**

Long Distance Receiver

Amazing Low Price!  
Quality Performance

Six tube triple screen-grid using 3-224, 2-227, and 1-245 power tube. Easy to install. Will fit any car. Single dial control. We guarantee that this set will pull in stations within a radius of 1,000 miles and that it will deliver the volume and tone qualities of an electric set, or your money refunded.

PRICE OF SET ONLY \$20.00

Price complete, including tubes, batteries, dynamic speaker and suppressors, all ready to install and use, \$39.50. Send \$5.00 deposit with order, balance C. O. D. On foreign orders remittance in full required. ORDER TODAY.

CHAS. HOODWIN CO.  
4240 Lincoln Avenue, Dept. J-150 Chicago, Illinois

\$20

# Learn Chemistry

## Dr. Sloane will Teach You in Your Own Home

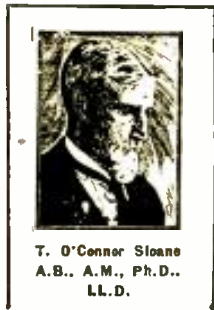

Chemistry offers those who are ambitious and willing to apply themselves conscientiously to the greatest opportunities of any vocation. Industrial firms of all kinds pay tempting salaries to get the right men. Opportunities abound on every hand.

### Now Is the Time to Study Chemistry

Never before has the world seen such splendid opportunities for chemists as exist today. In factories, mills, laboratories, radio and electrical shops, industrial plants of all kinds, chemistry plays a vital part in the continuation and expansion of the business. No profession offers such opportunities and the next ten years are going to show the greatest development in this science that this country has even seen.

### You Can Learn At Home

Our home study course, written by Dr. Sloane himself, is practical, logical and remarkably simple. It is illustrated by so many experiments that are performed right from the start that anyone, no matter how little education he may have, can thoroughly understand every lesson. Dr. Sloane will, in addition, give you any individual help you may need in your studies.

### Easy Monthly Payments

You do not have to have even the small price of the course to start. You can pay for it in small monthly amounts or earn it as many others are doing. The cost is very low, and includes even the Chemistry outfit—there are no extras to buy with our course.

### Experimental Equipment Given to Every Student

We give to every student without additional charge his chemical equipment, including fifty pieces of laboratory apparatus and supplies and forty-two different chemicals and re-agents.

### Tuition Price Reduced

Besides furnishing the student with his Experimental Equipment, we have been able, through the big increase in our student body, to reduce the cost of the course. Write today for full information and free book, "Opportunities for Chemists."

Mail the Coupon NOW!

**CHEMICAL INSTITUTE OF NEW YORK, Inc.**

HOME EXTENSION DIVISION  
19 Park Place New York, N. Y.

CHEMICAL INSTITUTE OF NEW YORK,  
Home Extension Division  
19 Park Place, New York, N. Y.

Please send me at once, without any obligation on my part, your free book "Opportunities for Chemists," and full particulars about the Experimental Equipment given to every student. Also please tell me about your plan of payment.

NAME .....  
ADDRESS .....  
CITY ..... STATE.....  
RC-931

# Control of Recording

(Continued from page 143)

is as shown in Fig. 5, and radio programs can then be recorded.

A novel feature of this control box is the "Mic." position, (See Fig. 6) which enables the operation to use the radio for announcements, etc. In other words, a very efficient public-address system is available.

When microphone recording is desired the knob is turned to "Mic. Rec.," as in Fig. 7; which is similar to the circuit of Fig. 6, except that the cutting head is connected to the plates of the output tubes.

Playback is accomplished by turning the knob to "Phono.," Fig. 8. This disconnects the microphone and cutting head and then connects the latter to the grid and cathode of the detector tube.

This about completes the discussion of control circuits for home recording. Of course, various trick circuits will be developed by many experimenters to suit their own particular needs. The writer will be greatly interested to see any of these circuit arrangements which recordists may care to send to him. Letters should be addressed in care of the Home Recording Department of RADIO-CRAFT.

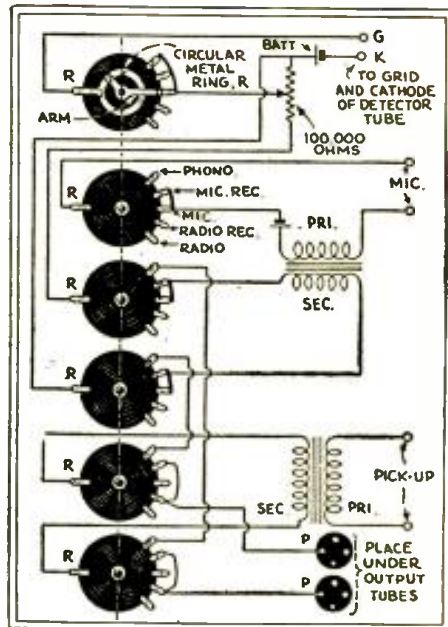
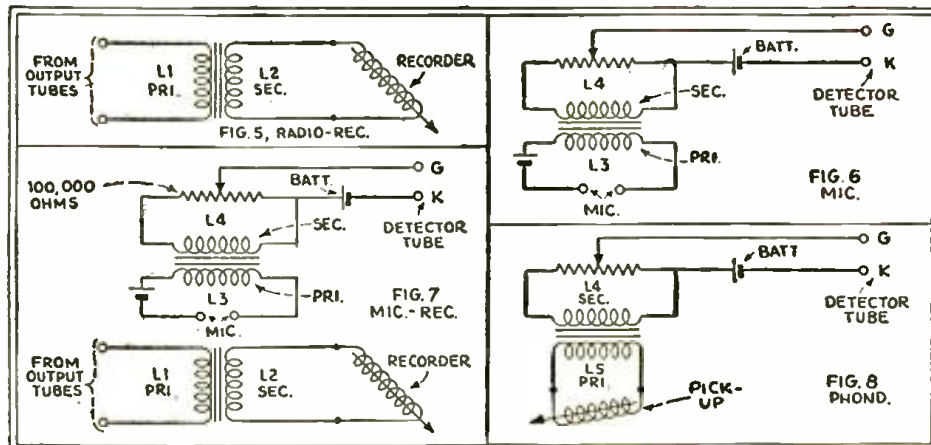

Fig. 4



The contact-plate connections of the Best control unit, illustrated in Fig. 4, are shown in Fig. 5, above. Various circuit connections obtained by the various positions of the switch are given in Figs. 5-8; for regular radio reception, the switch is put in position 5.

# Experiments in Home Recording

Editor, RADIO-CRAFT:

Remembering the fun we had recording on the metal composition discs with the old Victrola, I dug up some old recordings and played them on the electric phonograph. The voices were very faint, and I got to wondering if I couldn't make some new records—and I did, over the old blanks. These didn't amount to much, and probably I would have stopped right there, if Victor had not announced their home-recording outfit about that time. Since then I have used only their pre-grooved discs, and have made some fairly good records. Some would be very good, from the standpoint of volume and clearness, if the extraneous noises could be eliminated. Like most amateurs, I have found my difficulty in trying to get good results with a small outlay for parts.

The first essential is to have a really good motor and turntable. The motor must have

plenty of power; so that the table will turn uniformly, no matter how heavy a cut the stylus makes. I had mine rewound with wire two gauges larger, and this increased the power considerably; though it was a job to get on turns enough. The motor heats considerably, but they all do; it has never become hot enough to damage it. It is a shaded-pole induction motor; I have also a cheap little synchronous motor which I plan to couple to the turntable, to give more power and better regulation, when it becomes possible to buy larger records blanks.

The turntable must not wobble too much, or the record will sound as though you had turned the table by hand. If the table itself is out of a true plane, there is not much chance of springing it back. But if only the center hole is out of perpendicular to the table, patience and careful shimming on



the low side will make the table run quite true.

The recording head may be any of the better pickups; though I have had very good luck in using for this purpose a magnetic-cone unit from a Tower speaker; a needle chuck from an old Victrola sound box was soldered to the free end of the armature. The unit was then mounted on a center-balanced tone arm; and much experimenting with the spring's tension, armature's position, and damping with rubber was tried before the tone was clear and free from had distortion. This adjustment was effected while playing regular records, and with a circuit so arranged that a Webster pickup could be cut in for comparison.

It was my idea that, since a loud speaker is designed to convert electrical impulses into mechanical, it should therefore do a better job of recording than an instrument designed to reverse this process. (*The question of characteristics arises at this point. See Fig. 4, page 29, in the July issue, and accompanying text.*) Anyway, when I got through, I had a pickup that was very loud and clear and, as a recorder, it cuts a very wide sound track. (Sometimes, in fact, too wide; this may be due to the large double magnets, or the greater inertia, I don't know which.) For playbacks, I use the regular pickup.

Microphones are quite expensive and, until I was convinced that there was some hope, I didn't spend much on this item. I tried various mountings with all the mike buttons I could get hold of; rewound transformers trying to get a reasonable impedance match; and then turned back to my old friend the magnetic-cone speaker. These are cheap, and need no matching transformer to couple them into the audio circuit; but be sure you use one with strong magnets. Loosen the tension of the armature spring, and put from three to nine volts of battery in series with the speaker and the audio amplifier's input; this will boost the volume and increase sensitivity to the point where there will be plenty of microphonic howl if the mike and the speaker are in the same room. Try reversing the polarity if the mike lacks sensitivity. My outfit had plenty of wire on the mike; so I could go into the next room while adjusting it. (You can have an assistant beside the set to tell you when your voice comes through well.) This type of microphone is good enough to record a quartette and banjo, without too much crowding around it.

I use a small orthophonic cabinet to house everything, with the following switching arrangements: radio-record; voice-record; voice-loud speaker; record playback. The radio-phono switch on set gives you your choice there. I also put on the set a switch to cut out the voice coil, though this is not absolutely necessary. Connection of the set's output to the recorder is effected through an 0.5-mf. condenser on each side of the line, from the two plate terminals on the output transformer. (*Larger capacities might well be used.*)

If the same pickup is used for both recording and pickup, be sure your switching system makes it impossible to turn the set's output back into the detector. I use two rotary cam switches, mounted close together; with large knobs so cut away that

it is impossible to turn one unless the other is in the proper position. Perhaps someone has an idea for a rotary switch like Victor's that could be made from the junk box.

I understand that one of the home-movie companies is working on an outfit that will record the sound on cylinders; which will then be sent to the manufacturer, who will transfer the record to a permanent 16-inch disc. The question of permanence is one which I hope to see solved soon; also that of larger records.

We have in the family some old Edison home-recordings, made 22 years ago. These have not been played very often; but it is quite a sensation to hear yourself as you sounded then. There is also quite a kick in handing a mike to your most imperturbable friend and telling him to make a record. No matter how loquacious he is ordinarily, speech and ideas will desert him. When he finally stammers out something, and you play it back for him, he'll swear it's not his voice. But everyone else will declare it's just like him.

There is another use for these records that I have never seen mentioned; and that is for self-improvement. If you get a good mike and good results, have one of your musical friends play a solo, or do so yourself. The playback will reveal things the performer did not know before, some good, some bad.

I have made this letter purposely vague in details; for it is addressed to the fellow like myself who likes to roll his own.

W. A. WILKINSON,

1315 Thirty-First St., Des Moines, Iowa.

**AUTOMATIC PROGRAM CONTROL**

"SOME years ago" observes "Free Grid" in *Wireless World*, London, "a restaurateur approached me with the suggestion that I design him a wonderful set which would automatically switch itself off when speech came along and switch itself on again when music reappeared.

"I was rather amused at his suggestion, but, nevertheless, introduced him to a young friend of mine who was by way of being an expert on tone filters. I was surprised to learn some weeks later that he had jolly nearly succeeded and would have done so completely if he could only have persuaded the human voice to confine itself to one end of the musical scale. As it was, the apparatus actually did function after a fashion and switched off when an announcer with a certain type of voice came on the air. Unfortunately it suffered from the defect that it did not respond to all voices."

Another opportunity for the more persistent inventor, in these days of improved tone-control devices.

**"LOSING HIS FILAMENTS"**

MANY a radio fan has lost his, for reasons too painful to discuss; but the expression is now finding a special use in English broadcasting, according to *Amateur Wireless*. When a dull performer is before the microphone, the engineers in the control-room observe "I bet that fellow is losing his filaments"—i. e., the great public are switching off their receivers, alternative programs being less numerous abroad.

# Experienced Radio Men!

TO GET and HOLD down a better than average job you must be a better than average man.

ENGINEERING TRAINING is the solution.

Mail coupon for details of our plan TODAY!

CAPITOL RADIO ENGINEERING INSTITUTE, INC.

3166 Mt. Pleasant St., N. W., Washington, D. C.

Please send me, without obligation, your new illustrated booklet explaining your advanced course in Practical Radio Engineering.

Name \_\_\_\_\_

Address \_\_\_\_\_

Position \_\_\_\_\_ RC-9

## The ROOSEVELT



**SUPER-HETERODYNE**  
Uses new Pentode power tubes, also new type variable-mu screen grid. 7 tubes in all. 10 KC. separation, wonderful tone and great distance. "Litz" Bank - Wound Coils. The most perfect radio ever built. Price, complete with tubes \$64.50

### New CUB Midget

T.R.F. Circuit, Pentode, Variable - Mu, Fine Tone. Price complete, \$19.75.

Dealers and Agents: Write for Discounts! COMMONWEALTH RADIO MFG. CO. 843-B W. Harrison St., Cable: RADCOM, CHICAGO



AMPERITE corrects line voltage variations, Improves reception. Installed in 5 minutes. No chassis changes. \$3 at your dealers. Write Dept. RC-9, giving No. of your set. For Every Set, make and model Including Midgets.

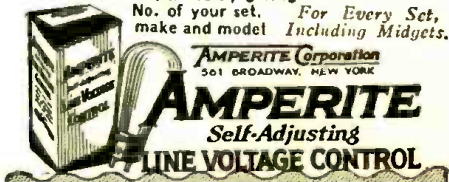

**PATENTS** Write for Free Guide Book, "HOW TO OBTAIN A PATENT" and Record of Invention Blank. Send model or sketch and description of your invention for our Free Opinion whether it comes within Patent Office Rules. RADIO and ELECTRICAL Cases a Specialty. Prompt, Efficient Service. PAYMENT OF FEES IN INSTALLMENTS VICTOR J. EVANS & CO., 923 - 9th, Washington, D. C.



**WORLD-WIDE SHORT WAVE RECEIVER**  
 ONLY 6.45  
 Span the World with this Set!

A new radio thrill for you! Listen in DIRECT to London, Paris, Berlin, Buenos Aires and other broadcasting stations throughout the world via short waves. Enjoy unique foreign programs from strange lands. Your ordinary receiver cannot tune in these low wave stations. WORLD-WIDE RECEIVER gets 14 to 550 meter stations with surprising clarity. **SEND NO MONEY!** Just write your name and address on a postcard and ask us to send you this wonderful guaranteed short wave set. Pay postman \$6.45 plus a small delivery charge. All orders West of the Rockies must be accompanied by \$1.00 deposit. Price in foreign countries, \$7.75 delivered. Order today!

**NEW RADIO BARGAINS**

- Low Power Transmitter adaptable for phone or code. With plug-in coils ..... \$14.75
- B Eliminator, Bone Dry with 280 tube, 180 volts, will operate up to ten tube set, fully guaranteed... 6.75
- AC—A B C Power Packs, completely assembled.... 8.75
- Tubes: UX type, 30-day replacement guarantee, No. 210, \$2.25; No. 250, \$2.45; No. 281, \$1.85; No. 245, \$1.25; No. 224, \$1.25; No. 227, 75c; No. 226, 65c; No. 171, 75c.

International Microphone, two button for public address system and transmitters, speech or music.....\$9.75

WRITE FOR BARGAIN CATALOG

CHAS. HOODWIN CO.

4240 Lincoln Ave., Dept. J-15, CHICAGO

**Soft Aluminum Pregrooved Blank Records for Instantaneous Home Recording. Double Faced.**

	<b>Give Volume Brilliancy Durability</b>
	<b>List Prices</b>
	6 inch \$0.50
	8 inch 0.75
	10 inch 1.00

Also Microphones—Double and Single Button, Transformers, Mounts, Cable, Plugs, etc. New 32 Page Catalog just out.

**UNIVERSAL MICROPHONE CO., Ltd.**  
 Inglewood Dept. R.C. California

**“Chirad”**

Full Information and Best Prices on the

**NEW S-M 726 SW**

Short and Long Wave Receiver

**NEW NATIONAL AC 5 SW**

Using 235 and 245 Tubes

Can Be Had By Writing to Us

Supplies of All Kinds for Short Wave Experimenters

**CHICAGO RADIO APPARATUS Co.**

415 So. Dearborn St., Chicago, Ill. Est. 1921 Dept. CF-9

**ALUMINUM BOX SHIELDS**

Genuine “ALCOA” stock, silverslip finish, 5 x 9 x 6, \$1.89—14 x 6 x 6, \$3.85, 10 x 6 x 7 Monitor size \$3.25. 5 x 5 x 5 Coll Shield (like picture on right) \$1.00.

Any Size to Order.

Pentode adapters, \$1.25. Patent Pick-up leads, only \$2.25 Flexible shafts for Antic Sets.



**“BUDDY” TEST PROD**

Always sharp pointed, using phonograph needles, 4-ft. wires, spade or phone tips. Colored nicks identify each lead, \$1.50 pair.

We specialize in radio parts exclusively—parts furnished for any kit in any magazine. Please include Postage.

**BLAN. THE RADIO MAN, Inc.**  
 89 Cortlandt St. Dept. RC-931 New York, N. Y.

**Single-Control Superheterodynes**

(Continued from page 165)

the frequency of oscillator circuits of the usual type.

The proportioning of the circuits is not difficult; the inductance of the oscillator coil being as specified by our empirical rule (about 22% less than the inductance of the tuning coils of the receiver proper), while the plate and grid coupling coils should be as small as will provide oscillation over the entire tuning range.

A study of the superheterodyne receivers now on the market will show that it makes little difference where we tie in the local oscillation: it may be introduced into the grid circuit or the plate circuit of the first detector, or into the screen-grid circuit if a screen-grid tube is employed for mixing. Care should be taken that the magnitude of this locally-impressed oscillation is not so great as to overload the detector tube or otherwise distort its output.

**Push-Pull with Screen-Grid Detector**

It is commonly understood that the screen-grid tube will not give good quality when employed with transformer or inductance coupling at audio frequencies. The reason is that the tube's impedance itself is so high that it is difficult to work into a favourable inductive load at the lowest desired frequency, without having windings so bulky as to raise the distributed capacity to a point where the high frequencies are no longer passed. In the reception of radio programs, however, we are not concerned with frequencies beyond 5,000 cycles (as we are in talking-picture work), since the administrative regulations affecting broadcasting prohibit the transmission of frequencies above this figure. We may, therefore, by careful consideration of the design problems, so arrange a transformer or impedance coupling, out of a screen-grid tube, that we retain all the desired modulation frequencies. This is done by employing transformers or center-tapped chokes with relatively small windings, and so proportioning the inductance and the coupling capacity that we improve the coupling at the low-frequency end of the spectrum—say at 100 cycles—by resonance.

The basic principle of push-pull opera-

tion is that the currents affecting the respective grids are 180 degrees out of phase—that is to say, the voltage in one branch assumes its maximum positive value at the same instant that the voltage in the other branch is most negative. By using a center-tapped choke, as an “auto-transformer,” the required phase reversal is obtained (Fig. 4).

Resonance at 100 cycles is obtained with the inductor shown (an Amertran “No. 641” A.F. choke having an inductance of 200 henries each side of the center tap) and a coupling condenser of approximately .025-microfarad. These values hold for any type of output tubes, V2, V3.

**Going After Service**

(Continued from page 145)

you with shipping and burdening you with express bills. A minimum stock can be carried, because of the ease of securing additional supplies.

Other, less-aggressive Service Men are going broke here; so, unless you can bring in new and more effective ideas for selling service, stay in your own home town.

One ten-by-ten room in my home contains my desk, phone, service bench, and shelves for spare parts and supplies. No sets are brought in that can be repaired in less than an hour in the owner's home. All my equipment is hand-made. Careful workmanship and technical accuracy make my instruments as important in the eyes of my customers as their more expensive ready-made counterparts. Besides, after designing and building an instrument, I know how to use it.

A 1928 light coach-model car takes care of the transportation problem.

I sell Crosley, Echophone and Majestic sets where old sets are too far gone to warrant expensive repairs. All business is done on a cash basis. I am not affiliated with any other dealer nor do I care for their work with its limitations on selling that it would impose upon me.

During the winter months, I teach radio service work two nights a week to a public night-school class under the auspices of the local board of education.

**The Sonora Specialist**

(Continued from page 149)

The tubes used are—with the exception of a 2.5-volt detector—of the Blue Sonora 15-volt filament type, with a separate heater connected to one side of the cathode; by which means they are able to employ UX tube bases, instead of UY. In the accompanying table, data for these tubes are shown. The RA-1 (general-purpose) type is equivalent to the Arcturus 15-volt type-48; the SO-1 (power amplifier) type to the Arcturus 15-volt type-40. Other tubes, used in Sonora models, the DE-1, RE-1, SO-2 and RE-2, corresponded respectively to the standard '27, '80, '50 and '81 types in general use. “Durasite” ballast tubes were used in two types; the “125” to drop line voltage from 110 to 85, at 0.75-ampere; and the “150” to do the same, under a load of 1.4 amps.

and the “32” use the same chassis, but without phonograph attachment. Three other models were made by the same manufacturer—the “36” has '50 type power tubes, and an additional R.F. stage; while the “44” and “46” are phonograph combinations, in different cabinets. While the manufacture of the line has been discontinued, parts are still available; and tubes are available under different type numbers.

**Average Tube Readings\***

	R.F.	Det.	A.F.	Power
	“RA-1”	“DE-1”	“RA-1”	“SO-1”
Filament, volts ....	15	2	15	15
Plate, volts .....	107	22	104	170
Plate, mills .....	43 $\frac{1}{2}$	1.2	4	12-23
Grid bias, volts....	4-6	0	4-6	36

\*These values are for 110 volts A.C. on the line and 88 on the transformer primary.

In addition to the “Model 40,” the “30”



# How to Test the Pentodes

(Continued from page 155)

The Na-Ald "975" adapter can also be used on the "Supreme" tube testers. Place the adapter in the five-hole or '27 socket. Set the filament switch at 2.5 volts, if a switch is provided for that purpose. If you are using a "Supreme" tester, insert the pentode tube into the adapter, in the '27 socket; emission current can now be read on the test meter. This adapter simply allows the screen-grid to be connected to the plate of tube.

Two adapters are required when using the Hickok "S-G 4600" tester. These adapters (Na-Ald "975H") are furnished in pairs connected together by an eight-inch lead (Fig. 8).

When making radio set measurements, first use the regular No. 1 cable for connecting to the receiver under test. Set the

To test the pentode with Sterling set testers, use a Na-Ald "954K" adapter. This is inserted in the four-hole socket of the tester; a lead is brought out from the cathode receptacle, and the cathode prong is dead. (Exact instructions on how to use this adapter were not available at this writing; however, by the time this is printed they will be available from the manufacturer.) Fig. 9 shows the connection for this adapter.

Two adapters are required in testing pentode tube circuits on the Supreme 400 series of testers. Different connections for the adapters are required for each type, and as there are seven or eight different models of the "400 series" testers involved, complete information on the exact way to use these adapters was not obtainable at this writing.

Na-Ald "No. 976" and "No. 977" adapters

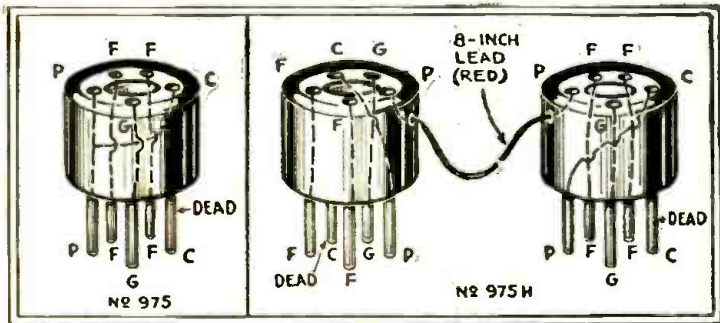

Fig. 7 (left)

Adapter used with Weston models "533," "555" and "565."

Fig. 8 (right)

Dual adapter used with the Hickok "S-G 4600" set tester for pentodes. The method is explained in the text.

filament-cathode switch to "Neg. Fil." position, and the plate milliammeter to read on the "high" scale. Next, insert the pentode tube in the '27 socket. Turn on the receiver; the plate voltage and current of the tube will now be indicated in the regular manner.

To test screen-grid voltage and screen-grid current, after making the above test, turn off the receiver switch and use the "975H" adapters as follows:

Insert one adapter into the socket marked "connector" on tester panel; the other adapter into the '27 socket. Next, insert the plug at the end of cable No. 1 into the adapter, which you have connected in the "connector" socket of the test panel; and the pentode into the adapter which you have connected to the '27 socket. Set the milliammeter on the "low" scale; the screen-grid voltage will now be indicated on the plate voltmeter and the screen-grid current on the plate milliammeter, after the switch of the receiver has been turned on.

are required. The "976" is a five-hole five-prong adapter. Refer to Fig. 10 for the connections, which are made from the socket of the adapter to the prongs of the adapter in the following order: plate to plate; heater to heater; grid to grid. The cathode prong is dead; while the cathode receptacle is connected to an eight-inch black wire with phone tip attached. This adapter is to be placed in the socket of the tester.

The "No. 977" adapter, to be attached to the test plug, is of the four-hole-five-prong variety. Refer to Fig. 11 for the connections, which are in the following order: plate to plate; grid to grid; and the plus side of the filament receptacle to the plus side of the filament prong. The negative filament prong of the adapter is connected to the center stud which, when attached to the test plug, makes contact with the latch on the plug. The cathode prong of the adapter is connected to a spade terminal, as indicated.

Information on the use of these adapters for the full line of Supreme testers will be available, by the time this is printed, from the Supreme Instrument Corp., Greenwood, Miss., or from the manufacturers of the adapters, the Alden Mfg. Co., 715 Center St., Brockton, Mass.

### Tests on Variable Mu Tubes

The 35 and 51 type variable-mu tubes present no additional testing problems, provided the control grid measuring facilities of the tester include a meter scale of at least 40 volts (negative). Most testers have a sufficient range for this purpose. The variable-mu tube will probably have a control-grid potential of as much as 40 volts negative at certain settings of the receiver's volume control, and, if the tester does not

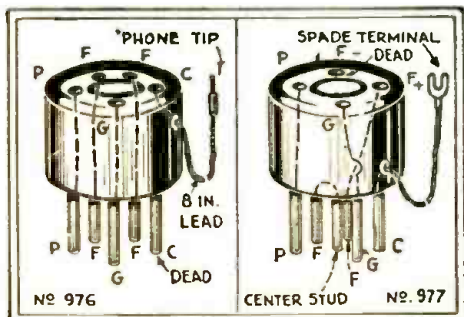

Fig. 10

Fig. 11

The two adapters shown are used with the "400" series of Supreme test instruments; one with the socket and one with the plug.

## SHORT WAVE TONE

Here is a new kink for the S.W. enthusiast. Cut out background noises and mushy tone with the CLAROSTAT TONE CONTROL panel mounting type.

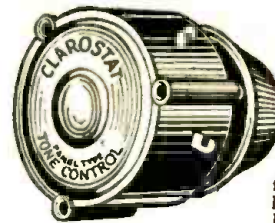

Just drill one hole and run two wires to a audio transformer — that's all.

Regularly supplied without wire or adapters, \$1.80.

Regular model for ordinary tubes. Pentode model for Pentode Output.

CLAROSTAT MFG. CO., Inc.  
285 N. 6th Street - Brooklyn, N. Y.

## Radio Dealers! Radio Service Men!

Guaranteed Replacement Condenser Blocks and Transformers

	Net
Atwater-Kent 37 Cond. Block with chokes.....	\$3.95
Atwater-Kent 37 Power Transformer.....	2.95
Atwater-Kent 40 Pack Complete.....	7.50
Zenith ZEB, Stewart-Warner, Mohawk Blocks	3.45
Majestic "B" Eliminator Cond. Block.....	2.95
Crosley Electrolytic Condenser, 2 Anode...	2.10
Crosley Electrolytic Condenser, 3 Anode...	2.75

Hard-to-get parts—We have them  
Send us your repair work for estimate  
Write for our FREE CATALOGUE

Grant Radio Laboratories  
6521 1/2 South Halsted St., Chicago, Ill.

## Study RADIO in CANADA

CANADA'S PIONEER COLLEGE, endorsed by leading radio manufacturers, offers DAY, EVENING, HOME STUDY and SPECIAL TRADE COURSES with free scholarships and trip to Toronto (all expenses paid). Write for booklet to Principal.

RADIO COLLEGE OF CANADA Limited  
310 Yonge Street - Toronto

**ELLIS Microphones**   
for **TONE**  
ELLIS ELECTRICAL LABORATORY  
337 W. MADISON ST. Sole Sales Corporation CHICAGO

## PATENTS — TRADE MARKS

All cases submitted given personal attention by members of the firm. Information and booklet free.  
Patent Office and Federal Court Practice  
**Lancaster, Allwine & Rommel**  
Patent Law Offices  
475 OURAY BLDG., WASHINGTON, D. C.

## New! For AUTO Radio

Types to Fit All Makes of Cars

## LYNCH

Spark Plug and Distributor Suppressors  
Metalized Principle Insures Dependability and Long Life. Write for Illustrated Catalog CS  
LYNCH MFG. CO., Inc., 1775 Broadway, N. Y. City

**PUBLIC ADDRESS EQUIPMENT**  
  
**MILES REPRODUCER CO.**  
26 E. 22nd ST. NEW YORK CITY



# The key to every radio problem

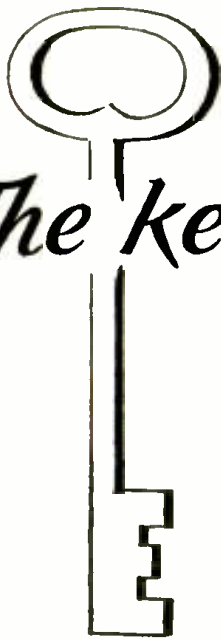

"Knowledge is of two kinds. We know a subject ourselves, or we know where we can find information upon it."  
—Samuel Johnson

2,201 Definitions  
1,253 Illustrations

352 pages.  
Size 9" x 12"  
Flexible Red Morocco-Keratol Gold-Stamped Cover.

## A SYMPOSIUM OF INFORMATION TOPICALLY ARRANGED IN ALPHABETICAL ORDER

This book is not a dictionary, but a true Radio Encyclopedia, covering Radio from A to Z. It is a large book of 352 pages, 9 inches wide by 12 inches high, and weighs three pounds. There are 2,201 radio definitions, A B C indexed like any dictionary, making every bit of radio information you want "findable"; 1,253 detailed technical

illustrations; 34 tables and charts; 24 pages of Appendix, etc. The binding is flexible red morocco-keratol, with title gold-stamped on cover and back-bone. The text is printed on durable, fine ledger paper, and the loose-leaf construction permits of new material being added, such as notes, addenda data, etc.

### WHAT THE NEW SECOND EDITION RADIO ENCYCLOPEDIA GIVES YOU

It gives you an explanation of every word used in radio. These explanations—or, rather, definitions—are not brief outline information like those of an ordinary dictionary, but they give in fullest detail, and at considerable length, the meaning and application of every word, phrase, general and special term used in the science of radio. They are written in plain, everyday English, easily understood by anyone.

Practically every definition in the book is illustrated by drawings, photographs, diagrams, or charts. All you need to do is to look up the word or phrase

about which you are in doubt, under its proper heading. ALL THE SUBJECT MATTER IS ARRANGED IN ALPHABETICAL ORDER.

Numerous tables, charts, and maps are distributed throughout the text. A large section of the Appendix contains information of commercial value, such as lists of all radio receivers, their manufacturers, trade names, tubes used, styles, etc. There are charts of tube-socket lay-outs of all makes of sets; broadcast stations listed by wave-lengths, call letters, towns and states, etc.

### ABSOLUTE GUARANTEE

If the book does not come up to your expectation, or is not as represented, or if you do not want it, for any reason whatsoever, you can return it and

have your money refunded, without question. Use the order blank below for convenience in ordering, and mail it to S. Gernsback Corporation.

S. GERNSBACK CORPORATION  
98 Park Place, New York, N. Y.

RC-9

Kindly send me one copy of the new Second Edition S. Gernsback Radio Encyclopedia. I will pay postman \$3.98 plus a few cents extra for carrying charges. (Foreign and Canada must remit with order, add 35c extra for postage). If the book does not come up to my expectations, or is not as represented, I can return it, and have my money refunded in full.

Name .....

Address .....

City ..... State .....

### SEND NO MONEY

Just fill in coupon at left and mail it TODAY.

We want you to be satisfied—keep it or return it—you have the option.

provide a meter of sufficient range, properly connected to measure this control-grid voltage, the control-grid circuit should be connected to an external meter range that will accommodate the applied voltage.

The adapters listed in this article make it possible to test the tubes and the tube circuits of the following pentode types: the '33, '38 and '47.

The '35, '36 and '51 type tubes are only special types of screen grid tubes; and the usual screen grid measuring methods may be followed when testing them; for their electrode connections are such that no change in tester design is necessary.

#### Auxiliary Pentode Tester

Fig. 12 shows the necessary connections. Socket No. 1 is the regular five hole socket of the tester; socket No. 2 is for a pentode Na-Ald "Type 427" or "465." Switches S1 and S2 are of the push-button type (such as Yaxley "No. 2004") which allow the proper meter scales to be read in reference to the control-grid and screen-grid circuits of the pentode. Switch S3 may be of the push-button, or a toggle type like the Na-Ald "2P2T". It is a double-pole double-throw unit, which breaks the grid and cathode leads of the test plug; connecting them to the control-grid and screen-grid of the pentode test socket.

Lead "A" connects to the negative terminal of any D.C. voltmeter having a scale exceeding 20 volts; and "B" connects to its positive terminal. Lead "C" connects to the negative side of a D.C. voltmeter, reading to 250 volts; and "D" connects to the positive terminal.

It is not advisable to attempt to add switches to connect the milliammeter in series with the screen-grid circuit, to measure screen-grid current. This measurement is rarely essential; and, when it is necessary, the external connections of the meter can be used.

If this external pentode test circuit is constructed, no switches except S1, S2 and S3 should be touched while testing the con-

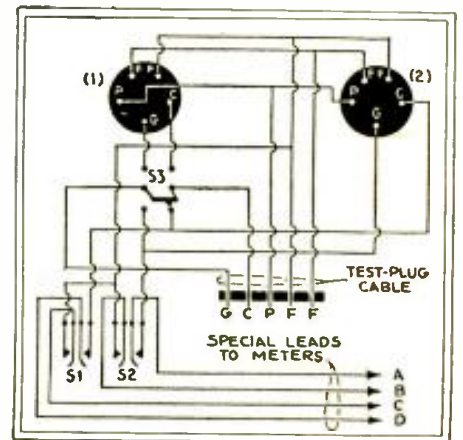

Fig. 12

Connections of an auxiliary unit for testing pentodes with any tester having a cathode circuit independent of the filament.

trol-grid and screen-grid circuits; after which throw S3 to the original position, and make the plate and filament tests in the usual way.

The writer will be glad to aid Service Men who may encounter difficulty in following these instructions, if he is addressed in care of this magazine.



## A. D. C. Converter

(Continued from page 159)

C2 should have a high-ratio vernier dial, for it tunes very sharp.

All resistors are bypassed; as we have radio frequencies only to deal with, 0.1-mf. will be large enough. Some localities require large filter condensers; and I have found places where only one 2-mf. unit, placed after the choke, answered all requirements. But it is better to play safe and place about two or more microfarads on each side of the choke.

Ordinarily we can get by without any bias on the oscillator tube V2; but, since we are using the same voltage on the plate of this tube and on the screens, it will be better to put a small bias on this tube. About 300 ohms at R2 will be O. K.; this value is not critical.

(The coil values given by Mr. Smith indicate tuning ranges from about 25 to 40 meters, and from about 50 to 80. The constructor, of course, may use more coils, and in other combinations, to suit himself.)

## Short-Wave Converters

(Continued from page 160)

are tied together and connected to one side of the primary of the power transformer. The cathode is brought to the positive side of the "B" supply. For satisfactory filtration, condensers of high capacity are required. These may be of the 8-mf. "dry electrolytic" type. Nearly perfect filtering is necessary; for, if a hum is present, it modulates the beat frequency, making tuning difficult.

Very seldom does noise originate in the converter, that is, if proper parts have been used in its construction, and care has been taken to do a good job of the wiring. The real "noise," however, is that which is picked up, when tuning in, especially for distant stations; the level of this noise varies with the location and atmospheric conditions. It must be remembered that the converter-receiver combination provides great sensitivity and, therefore, the chance of noise pick-up is greater than with the broadcast set alone.

Lastly, before condemning the converter, check up, by means of a good short-wave station list (such a list is published in each issue of *SHORT-WAVE CRAFT—Tech. Ed.*) to determine the probable operating hours, type of programs, and frequency setting of a given station.

### A SPEAKING LABEL

IN the Science Museum of South Kensington, London, which houses, among other exhibits, the special receiver described in the April and May issues of *RADIO-CRAFT*, a new automatic phonograph system has been installed. Any visitor, wishing to be told about the contents of a show case equipped with such a device, presses a button. The instrument starts into operation; delivers its message; and then switches itself off and returns to the starting position for the next question. A similar method is used to give instructions for finding certain exhibits.

# GREATEST TUBE SALE OF 1931

The Largest Variety of Tubes in the World

THIS SALE has been especially arranged for service men, dealers and radiotricians and a large supply of tubes are always on hand. These tubes are made by one of the largest Eastern tube manufacturers. This is your opportunity to buy tubes at lowest prices.

All tubes are guaranteed to be first-grade quality—comparable to the best obtainable on the market today. We will replace within 30 days any tube that has not given complete satisfaction.

Such an amazing tube sale has never been conducted.

### COMPLETE STOCK ALWAYS READY FOR IMMEDIATE SHIPMENTS

Order from this page and note the following terms: No orders accepted for less than \$5.00. It is not necessary to send the full amount of cash with the order as long as your order is

accompanied by 20% of the value. Shipment will go forward to you by express or parcel post C. O. D. All prices are F. O. B. Factory, Newark.

UX-201A .....	.30	Special 171 AC1-2 amp. extra coated filament—good for electric sets .....	.60	UX-233—Power Amplifier Pentode D. C. .....	.85
UX-226 .....	.30	T-14 (201A High Mu) high emission .....	.60	UX-236—Screen Grid Radio Freq. Amp. (D. C. Heater) .....	.85
UX-227 .....	.30	Switch tube, 201A or 112 or 171 double life .....	.60	UX-237—Detector Amplifier (D. C. Heater) .....	.85
UX-171A .....	.30	Adapter tube 226, 227, 171A, to convert bat. sets to AC, each .....	.60	UX-238—Power Amplifier Pentode (D. C. Heater) .....	.85
UX-171 .....	.30	UX-210—For power amplifier, high voltage .....	1.10	UX-230—Dry cell amp. and detector .....	.60
UX-210 .....	.40	UX-250—Power amp. used in last stage of audio freq. .....	1.10	UX-234—Dry cell amp.—last audio stage .....	.60
UX-120 .....	.40	All bakelite shield tube 201A .....	1.00	UX-232—Dry cell screen grid amp. .....	.60
UX-199 .....	.40	UX-222—Screen grid radio frequency amp. .....	1.10	UX-217—Power pentode .....	.85
UX-199 Standard base .....	.40	Tellon Television Tube 1" Cathode Square .....	3.85	UX-235—Super control screen grid amp. .....	.85
UX-112 .....	.40	Tellon Television Tube, 1 1/2" Cathode Square .....	3.85	UX-551—Variable Mu .....	.85
UX-200A .....	.40	Photoelectric cell, 2-inch .....	3.85		
UX-221 .....	.40	WD-11—Detector Amp. .....	.60		
UX-215 .....	.40	WD-12—Detector Amp. .....	.60		
Quadrode 5-prong 200A for special circuits .....	.60			Ballast tube to prevent tubes in set from blowing out .....	1.00
Special detector tube 200A—a super-sensitive detector .....	.60				
Special radio frequency 201A—a super-sensitive 201A .....	.60				
Special audio frequency 201A—a super-sensitive 201A .....	.60				

### Rectifier and Charger Bulbs

125 Mill. rectifying tube (R. H. type) .....	\$1.40
5/10 amp. trickle charger bulb .....	2.00
2 amp. old and new type charger bulbs (list \$1.00), our price .....	2.00
5 and 6 amp. old type charger bulbs (list \$8.00), our price .....	3.75
UX-280—Used as a full-wave rectifier for high emission .....	.40
UX-281—Half wave rectifier .....	1.10
Rectifying Tube especially designed for use with Presuman Master "B" Eliminators UV brass base, limited quantity .....	1.10
UX-806—Half-wave Rectifier mercury vapor .....	5.00

Discounts: 100 tubes and over 10%  
500 tubes and over 10% and 10%

**ARCO TUBE COMPANY, 38-40 Park Place, Newark, N. J.**

Right Now!!  
Send for Our

# NEWEST CATALOG

Largest Assortment and Biggest Bargains in  
**RADIO SETS AND PARTS**  
All Merchandise at Wholesale!

**S. HAMMER RADIO COMPANY**

142 Liberty Street, N. Y. City Dept. R Hltchock 4-1152

## CLASSIFIED ADVERTISEMENTS

Advertisements in this section are inserted at the cost of ten cents per word for each insertion—name, initial and address each count as one word. Cash should accompany all classified advertisements unless placed by a recognized advertising agency. No less than ten words are accepted. Advertising for the October issue should be received not later than August 7th.

### DETECTIVES

DETECTIVES Earn Big Money. Excellent opportunity. Experience unnecessary. Particulars Free. Write, George Wagner, 2190B Broadway, New York.

### FORMULAS

MAKE AND SELL your own products. We will furnish you any formulas. Write for our literature. Chemical Institute, 19R Park Place, New York, N. Y.

### PERSONAL

IF you want to get acquainted? Send for my big (free) list of introductions! Box 100-AAA. Detroit, Michigan.

### RADIO

SERVICE MEN, ATTENTION—Speakers rewound, magnetized, repaired, \$2.00 to \$2.75. Complete Power Pack Service—Transformers rewound, condenser blocks repaired, resistors duplicated. Guaranteed. Clark Brothers Radio Co., Albia, Iowa.

WANTED—S-M 690 Amplifier, used. A. B. Clark, Albia, Iowa.

SERVICE SHOPS—we specialize in rewinding power transformers. Try us. Supreme Radio Laboratory, 16 Fulton Ave., Rochester, N. Y.

### Radio's Greatest Service Manual

is now in the process of preparation. Be sure to read the announcement on pages 176 and 177 and learn about the many new things that are to be incorporated in the 1932 OFFICIAL RADIO SERVICE MANUAL.

# Hotel Directory of the Radio Trade

The hotels on this and opposite page are patronized by the Radio Trade. Make them your headquarters.



Typical room, converted at night into a sleeping room.

Enjoy the Comfort of a Real Home in

NEW YORK'S FINEST RESIDENTIAL HOTEL

The **GEORGE WASHINGTON**  
Lexington Ave. 23<sup>rd</sup> to 24<sup>th</sup> St.

Only a few quick minutes from business, shopping and amusement centers, yet you will enjoy the quiet repose of a country town at evening. Such is the fortunate location of the George Washington Hotel, a distinguished residential hotel.

**ROOM WITH BATH**  
DAILY **\$2.50 to \$3.00** WEEKLY **\$14 to \$17.50**  
THE BEST FOOD IN NEW YORK

## The Home Hotel of New York

Homelike in service, appointments and location... away from noise and congestion, yet but a few minutes from Times Square... garage facilities for tourists.

Room and Bath from \$3 single \$4 double  
500 Rooms

Home folks will like this hotel

**HOTEL**

**BRETTON HALL**  
BROADWAY at 86th ST.  
NEW YORK

Full details about the OFFICIAL REFRIGERATION SERVICE MANUAL appear on page 136 of this issue. If you have not yet familiarized yourself with the contents of this important Refrigeration servicing book do not fail to read the announcement which tells all about it.

## Short-Wave Coils

(Continued from page 165)

The presence of this extraneous inductance has its effect on the tuned circuits, which is considerable at the highest frequencies, and not easily predictable. The presence of parallel wires also increases high-frequency resistance.

### "Skin Effect"

The last-named effect, which is due, like the lowered inductance explained before, to the internal flux in a wire driving the electrical current to the surface ("skin effect") is very great at the highest frequencies. For instance, the resistance of a piece of straight No. 18 wire at a radio frequency of 1,500 kc. (200 meters) is five times its resistance to direct current. At 12,000 kc. (15 meters) the resistance is nearly fourteen times as great.

Small wire, however, shows this effect to a much lessened degree; the resistance of No. 36 wire has only doubled at 12,000 kc. This is in a straight length of wire; and the increased inductance of the coil increases even more the disadvantage of the larger wire, the interior of which carries comparatively little current. For this reason, in transmitting work on short waves, where it is necessary to have conductors capable of carrying heavy current of ultra-high frequency, tubes or ribbons are used instead of heavy wire.

The use of "Litz" wire (composed of many very fine wires, insulated from each other, and stranded) was at one time in vogue to overcome skin effect; but the best present-day coil construction, for the shorter waves, uses plain wire, with light insulation (enamelled or single silk) or even bare; but wound evenly on forms which it touches at as few points as possible, and

well spaced from the supports, which are threaded to give accuracy of spacing and prevent the wire from slipping. Standard plug-in forms, threaded for winding, are obtainable from several manufacturers; and experimenters who have lathes have threaded their own forms (such as tube bases) for the same purpose.

TABLE V

HALF-INCH FORM (Inductances in Microhenries)						
No. of Turns on Coil	7	Number of Turns of Wire Per Inch				60
		11	17	25	35	
3	.088					
5	0.17	0.23				
7	0.25	0.36	0.48			
10	0.38	0.56	0.78	1.00		
15	0.69	0.88	1.28	1.75	2.08	
20		1.22	1.78	2.46	3.06	
25			2.24	3.19	4.0	5.4
30			2.67	3.96	5.0	6.9
40				5.43	6.6	9.8
60				7.10	9.0	12.8
80					11.0	16.6
75						20.4
100						28.4

An additional table will be of interest, though more appropriate in connection with the preceding article: the number of turns of each gauge of wire which can be wound in an inch of space on the form, as determined by the insulation. The "bare wire" turns are given also, for the purpose of showing the comparative spacing of the conductors on a short-wave form. For instance, there are 50 turns of No. 24 bare wire in an inch; if it is wound 25 turns to the inch, the turns are spaced by their own width. The less insulation around the wire, if it is wound on a ribbed, highly-insulating form, the less the capacity of the coil. If the winding is protected, therefore, bare wire is better than enamelled, enamelled is better than single-covered, etc.

TABLE VII

NUMBER OF TURNS OF WIRE PER INCH, WOUND CLOSE TOGETHER														
Gauge	16	18	20	22	24	26	28	30	32	34	36	40		
Bare Wire	20	25	32	40	50	63	79	100	126	159	200	317		
Enamelled	19	23	29	37	46	57	74	90	112	141	178	270		
Sing. Silk	18	23	29	36	44	54	67	82	99	119	140	200		
Silk Enam.	18	22	27	34	42	51	63	76	92	110	131	185		
Doub. Silk	17	22	27	33	41	50	60	71	83	97	111	140		
Sing. Cot.	17	21	26	33	40	48	59	70	82	95	108	139		
Cot. Enam.	16	20	25	31	38	46	56	66	77	89	102	139		
Doub. Cot.	15	19	23	29	34	41	47	54	60	67	74	102		

## Radio Craftsmen

(Continued from page 170)

angles to the transformer winding reduces the effect to zero; and the return to parallel gradually increases the effect.

The circuit will show that this principle is incorporated; the primary, secondary and variable condenser forming the circle. The theory is that we have one frequency to amplify; whereas in the standard transformer we are very likely to have at least two frequencies, especially at the lower wavelengths. The primary of the standard transformer will track or follow the secondary very well on the long waves; but on



the short waves it has a tendency to vibrate at its own frequency. Hence we have a difference in frequency, which causes trouble in a tuned radio-frequency set.

Do not confuse this transformer with the single-coil type which is tapped near the lower side. The main difference is the fact that the winding in the single tapped coil is running in the wrong direction; hence it does not produce a gain. The input of the primary should run in the same direction as the grid return of the secondary. The primary of this transformer produces a gain and does not tune broad, as is the case with the tapped coil.

The primary is bunch-wound, and placed either inside or outside the form at ground-potential side of secondary. The bunch winding gives considerable gain over the ordinary flat winding. The secondary is wound in the usual flat method.

The form used is 3 inches in diameter. The antenna coupler has 12 primary turns, 48 secondary; the interstage couplers 15 primary turns, 45 secondary.

R. G. COYNER,  
RFD. 2, Delaware, Ohio.

(Mr. Coyner's first circuit used a separate voltage of 30 on the screen-grid of the detector, and 60 volts on the plate, with a .001-mf. capacity across the primary of the audio-frequency transformer, while an adjustable condenser was inserted between the plate and the primary of the detector coupler, as shown in dotted lines. This, however, he found unsatisfactory.

The functioning of a transformer of the type shown, where the tuning condenser is in shunt across both primary and secondary, is rather complicated for analysis. It does not appear, however, that any variometer effect is intended. Craftsmen who try the experiment may be interested in discussing it directly with Mr. Coyner.—*Editor.*)

COMMENTS AND QUERIES

*Editor, RADIO-CRAFT:*

For over a year I have been building three-tube A.C. sets, using '27 type tubes; and my pack is practically the same as that described on page 746 of the June issue by Mr. Morris. Here is one thing I want to ask you or Mr. Morris: how can he ground the "B—" without blowing a fuse in the A.C. line, since one side of the A.C. potential is "B—"?

(With this type of A.C. power pack, as with a D.C. electric receiver, the set should be connected to ground only through suitable condensers of fairly high capacity; that is, if any ground connection is desired other than that through the light line, which may be sufficient. The same precaution may well be taken with the aerial, to prevent trouble from a reversal of the light-socket plug.—*Editor.*)

The material used in my pack cost \$1.07 (mail order prices) without the tube, and its output is sufficient for three '27s. Without a ground, my little set plays 40 stations, many on the loud speaker. The '27s used as rectifiers have stood up a year, and no one could expect more than that.

I noticed in Mr. Nason's article on the pentode receiver, that 510 ohms was used as the biasing resistance for a PZ tube. The manufacturer of a similar tube specifies 420. (All tubes are not exactly average

in their characteristics. The resistor used by the author of the article in question was adjusted by him to the particular tube used. As a matter of fact, a pentode will operate, though not at full efficiency, even with the 1,500-ohm resistor of a '45 in its cathode return.—*Editor.*)

I built the "Air King," super converter shown in the same issue, and am so enthused with its working that I send a small contribution in the way of a diagram on how to hook phones or a magnetic speaker to a single audio stage. This gives a real kick; while you don't get volume when phones are connected across the output transformer's secondary. The idea may seem simple, yet one factory for which I am a dealer could give me no help on their particular set.

C. W. BROOKS,  
Northville, Michigan.

(The method illustrated by Mr. Brooks, it is interesting to note, was the same as that employed by Mr. Nothelfer, who tells of his experience elsewhere in this issue; except that the former used a 2-mf. coupling condenser.

The problem of attaching additional reproducers to modern sets has puzzled a good many Service Men and set owners; not so much for lack of theory as because of the mechanical difficulty of finding a place to connect to the plate circuit. The most common "Hint to Manufacturers" received from our readers in the past year dealt with this very subject; suggesting that a binding post be incorporated in some accessible place. In the meantime, the use of adapters will undoubtedly give many set owners this desirable convenience.—*Editor.*)

USING LOTS OF TUBES

*Editor, RADIO-CRAFT:*

I have been experimenting with radio ever since 1923, and still find new things about it every day. I have at the present time here a set that I have constructed for the broadcast band that I think cannot be beat for its details. It is a battery-operated receiver, with five '32's, a '30 detector, and two '45 audio stages. It is double-decked for compactness, and has six tuning condensers, in two triple gangs coupled on either side of the tuning dial. Six heavy-duty 45-volt "B" batteries are used, and 45 volts of "C"; 270 volts is applied to the plate of the '45's, and 15 volts to their grids. Standard plug-in R.F. screen-grid coils are used; two 2:1 A.F. coupling transformers, and a 1:1 output transformer. A 20-ohm rheostat cuts down the voltage applied to the 2-volt tubes, which is regulated with a voltmeter on the panel; and the filaments of the '45's are in series. The panel and subpanel are each 7 x 24 inches.

I think that this is a good receiver for the market and might be worth publishing for the experimenter to try. It has wonderful tone and plenty of volume—just like an A.C. set in power.

BEN F. LOCKE,  
Marthaville, La.

(The diagram of Mr. Locke's "Super Eight," which accompanies his letter, is too large to print here at this time. The R.F. stages are unusual only in number; the screen-grid R.F. chokes are bypassed on each side, with 0.25-mf. condensers; the plate leads are bypassed to filament with

**THE NEW HOTEL LINCOLN**  
EIGHTH AV.—44<sup>th</sup> 45<sup>th</sup> STS.  
Just a Step from Broadway  
NEW YORK CITY

The New and Beautiful  
**HOTEL LINCOLN**  
You are assured of MAXIMUM COMFORT and MAXIMUM SERVICE

1400 Rooms, each with tub and shower—Servidor

SINGLE:  
\$3.00, \$3.50, \$4.00, \$5.00  
DOUBLE:  
\$4.00, \$5.00, \$6.00, \$7.00

RADIO—DeForest Direct—now being installed in every guest room

**ROY MOULTON**  
MANAGER

The Crossroads of a Nation  
THE DRAKE is admittedly one of the great hotels of the world ... the stopping place of seasoned travelers. Rooms are spacious and smartly elegant ... continental atmosphere. Available, also, is an experienced Travel Bureau ... to relieve you of every travel detail. Rates begin at \$4 per day. Permanent Suites at Special Discounts.

**THE DRAKE HOTEL, CHICAGO**  
Under Blackstone Management

"AN ADDRESS OF DISTINCTION"

# Short Cuts TO RADIO Servicing

With the

## Radio Service Man's HANDYBOOK

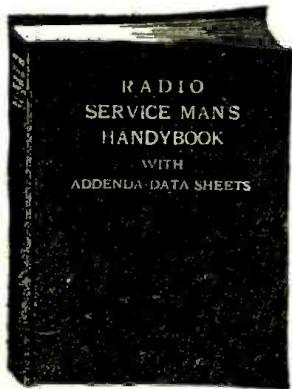

THE RADIO SERVICE MAN'S HANDYBOOK contains a tremendous amount of authentic material and practical information on Modernizing old receivers; Servicing obsolete sets; Repairing power packs; Construction of test laboratory equipment; Vacuum tubes; Set testing with analysers and hundreds of other similar subjects. Among the contributors are Bertram M. Freed, Leon L. Adelman, Paul L. Welker, Sylvan Harris, C. W. Palmer and others.

The HANDYBOOK enables service men to record notes, diagrams and charts on the special 40-page section of specially ruled sheets included in the book.

Hundreds of Diagrams, 200 Pages, 9 x 12 inches

Mail Coupon NOW!

GERNSBACK PUBLICATIONS, Inc. RC-9  
98 Park Place, New York, N. Y.

I enclose herewith check or money order for Two Dollars for which you are to send to me, postage prepaid, the Radio Service Man's Handybook.

Name .....

Address .....

City .....

State .....

2-mf. components. No bias seems to be applied to the R.F. grids, however; though this should be readily obtainable with a 6-volt battery. The employment of a '45 for the first audio stage, with so high a plate voltage, appears undesirable, though the purpose is obvious—to utilize the odd 2½ volts left over from the filament of the power tube. "Paraphrasing"—see page 650, May issue—is better; and even a '27 properly coupled would give more voltage amplification with less plate current. While no volume control is shown, it may be possible to operate this receiver satisfactorily, where there is no interference from nearby stations, with a short antenna. It would seem to lend itself to use with a loop. We have here, however, the reverse of the principle of commercial design—which is to get the most out of the least components.

Since a number of new battery tubes have been developed during the past few weeks, the task of building battery sets of high amplification and not too much current consumption has become simplified. With a '27 detector feeding into a '47 pentode, superior results should be obtained, with one less stage. Then, too, the '33 type 2-volt pentode will furnish sufficient power for a magnetic or inductor-dynamic reproducer in the home.—Editor.)

### FIXING POOR TUBES

Editor, RADIO-CRAFT:

I have found this magazine very good, right from the start; as some of the other radio periodicals are too full of feature articles, and have not enough concise theoretical and practical dope, so to speak.

Here's a wrinkle I don't remember reading of: though I have found it to be very much worth while as a money saver, though the idea was at first scoffed at by my side-kicks.

Some '45, '80, '81 and '50 tubes appear to go defective without the filament lead being broken; and some will fade in and out, or even appear to be burnt out, though the filament seems O. K. In nearly every case, I have saved the tube by unsoldering the filament prong and filling the inside of it with solder, by the use of plenty of rosin paste. It has usually been on account of poor soldering that the trouble starts. I have known tubes to go dead after being in use a few months; and this resoldering fixed them. The idea is well worth while.

A. L. BAILEY,

15 Hazley St., No., Hamilton, Canada.

### Improving Treble Quality

(Continued from page 169)

necessary only to adjust the midget condensers so that they compensate the capacities from grid to plate of the vacuum tubes employed.

In the case of the '71A tube (C g-p = 8.2 mmf.) particularly, these condensers may be employed with readily noticeable improvement in the high-frequency response.

To establish the condition of complete neutralization, open the filament circuit of both tubes, and insert a pair of phones across the speaker terminals. Vary the two condensers simultaneously until no signal comes through. Neutralization is then perfect.

# "The Short Wave is the most important thing in Radio."

*Guglielmo Marconi*



On All Large Newsstands

4-Color Cover 9" x 12" in Size Over 200 Illustrations

RAPIDLY increasing each day are the number of experiments in the Short Wave field—developments which are bringing to this branch of radio thousands of new "thrill seekers." Experimenters, as in the early days of Radio, again have the opportunity to bring about stirring new inventions. Read in SHORT WAVE CRAFT, the *Experimenter's Magazine*, how you can build your own Short Wave Sets, both transmitters and receivers. SHORT WAVE CRAFT is exclusively a short wave magazine—the kind you have wished for so long.

### Regular Departments in SHORT WAVE CRAFT

- Photographic Section—pictures of latest short wave sets and stations;
- Transmitters for short waves and how to build them;
- Short wave receivers—construction of all types and kinds;
- The Short Wave experimenter;
- Television on Short Waves;
- Short Waves for the broadcast listener;
- Ultra Short Waves;
- Aircraft Short Wave sets;
- How to build Short Wave aerials;
- Short Wave Question Box.

- Interesting Articles in the Current Issue
- "P. C. J."—Holland Speaking
- Europe Spans the Atlantic on Short Waves
- Baird Combination Short Wave and Television Receiver
- The Kennedy Short Wave Converter
- Scott "All-Wave" Super-Het Provides World-Wide Reception
- Transmitting Tubes to Fit Your Short Wave Problem
- A Low-Cost Push-Pull C-W Transmitter
- Short Wave Stations of the World
- A "Five Meter" Receiver
- How to Build Your Own Phone Transmitter
- Short Wave Tuning Less Plug-In Coils
- Experiments with Simplified Remote Control
- When to Listen In
- Winners in \$2,000 Amateur Station Contest

### SPECIAL OFFER COUPON

SHORT WAVE CRAFT RC-9  
98 Park Place, New York, N. Y.

I enclose herewith my remittance of \$2.00. (Canada and foreign \$2.50) check or money order preferred, for which you are to enter my subscription to SHORT WAVE CRAFT for One Year, also send me the last two issues gratis. I understand that the regular subscription rate is \$3.00 and this offer will be void after August 31. SHORT WAVE CRAFT is published every other month.

NAME .....

ADDRESS .....

CITY..... STATE.....



**Radio Book Review**

**EXPERIMENTAL RADIO ENGINEERING**, by John H. Morecroft. Published by John Wiley & Sons, New York. 6 x 9 inches, 346 pages, cloth; 250 illustrations. Price \$3.50.

This work, by the author of the universally-known *Principles of Radio Communication*, and the later *Elements of Radio Communication*, who has been for years professor of electrical engineering at Columbia University, is arranged in the form of 51 laboratory experiments, such as might be performed by a student engineer. It is avowedly a student's book; devoted to the principles of radio apparatus, rather than their application, and intended to accompany a course in electricity in the classroom.

The author has avoided the higher mathematics so far as possible; though a few expressions are beyond high-school algebra.

An idea of the program thus laid out may be gained from some of the experiments prescribed: (6) Resonance in a circuit containing coil and condenser in series; effect of resistance on shape of resonance curve; calculation of decrement from shape of resonance curve and from the constants of the circuit; effect of putting voltmeter across the condenser; (13) measurement of characteristics of a horn-type loud speaker by A.C. bridge, effect of clamping the diaphragm; effect of horn; dynamic speaker with and without exciting field; (28) Measurement of resistance and reactance of a tuned circuit as these are affected by the regenerative action of a triode; bridge measurements; (39) study of cathode-ray oscillograph and its use in measuring transformer ratios, hysteresis, and frequency-ratios; (49) Study of modulation; resistance modulation; plate-circuit modulation; grid-circuit modulation; energy distribution in a modulated wave."

As laid out by an able teacher of radio engineering, the prescribed course should give the student a thorough foundation for the practical work of his profession.

**TELEVISION TODAY AND TOMORROW**, by Sydney A. Moseley and H. J. Barton Chapple. Published by Isaac Pitman & Sons, New York. 5½ x 8¼ inches, xviii, 130 pages, cloth; 87 diagrams and plates. Price \$2.50.

This is an English work; in the introduction Mr. Moseley remarks that, in contemporary works "only the American side of television was stressed; it is only meet, then, that we should balance matters by telling the story of the progress of Baird television." To that purpose the book is therefore devoted; though pages 124-128 inclusive are allotted to "Television in Other Countries."

The description of the different stages of John L. Baird's television system as well as recounting the obstacles surmounted by this distinguished inventor, occupies the rest of the book. The claim is here set down, for future historians of the art, that the first public demonstration of the transmission by television (wired) of a recognizable human face was that made by Baird before the Royal Institution at London on January 27, 1926.

The technical matter contained in the book is written for the comprehension of any radio fan (though in British terms) and deals with the problems of radio reception, as well as the television. The work belongs in the library of any serious television experimenter, if only to show him what has been done, and what has been already discarded.

In the foreword, Mr. Baird himself declares: "The speed of picture transmission in television is not bound by the laws of cinematography."

**FOUNDATIONS OF RADIO**, by Rudolph L. Duncan. Published by John Wiley & Sons, New York. 5¼ x 7¼ inches, ix, 246 pages, cloth; 145 illustrations and numerous tables. Price \$2.50.

The author of this work has devoted many years to the practical instruction of students of radio, for the government and educational institutions; lately as president of RCA Institutes, Inc. He is known also as the co-author of *Radio Telegraphy*

and *Telephony, the Radio Traffic Manual, and How to Pass U. S. Government Radio License Examinations*. The fruit of long experience has been brought to this work, which has been designed especially for the *beginner*—the student who starts from scratch, without knowing an antenna from an ampere, and finds the first lessons the hardest. It is therefore recommended by the author that Chapter I—"Electrical Units"—"should be studied in detail after the contents of all subsequent chapters have been learned. This advice is offered because it is usually difficult to grasp the meaning of electrical and radio units from the first reading." The mathematics are simple and, for the benefit of the elementary student, a final chapter on "Preparatory Mathematics" is added, to explain problems which might otherwise puzzle one whose early education has been neglected.

There is practically nothing of radio in the book; it is devoted to the subjects which must be understood *before* it is possible to study radio profitably—electricity, magnetism, and sound. In other words, it covers elementary physics, so simply and clearly that it may be recommended to the student who has to dig out an education for himself. The tables contain many useful facts, which it is desirable to have at hand for future reference.

**Information Bureau**

(Continued from page 173)

that the wiring and components are changed to permit operation with the latest tubes; this usually necessitates redesign of the power pack. In some cases the R.F. coils are replaced; a more modern volume control usually becomes necessary; a tone control usually improves the audio quality. Single-dial tuning may replace multi-dial operation; a power detection circuit improves the tone quality, as does the use of a pentode or other high-power output tube. Perhaps the major alteration is the use of A.C. tubes in place of battery-operated tubes.

Most of these changes are described in detail in the "Radio Service Treatise," copies of which are available gratis by addressing an inquiry to this department.

**— — RADIO'S BEST BUYS TODAY! — —**

**LOFTIN WHITE AMPLIFIER Licensed**



Model 245 uses:

1-224, 1-280 and 1-245.

Price **\$12.95**

Model 250 uses:

1-224, 1-281 and 1-250.

Price **\$16.95**

We build all types of public address systems to order.

We also stock all popular makes of amplifiers.

**DYNAMIC CHASSIS at Reduced Prices**

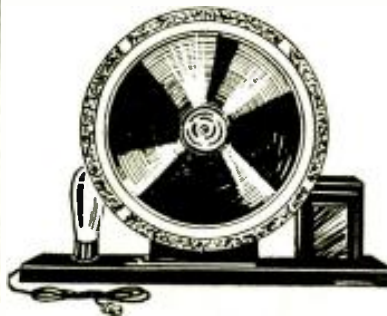

Oxford

- 14" using 280 tube..... **\$12.95**
- 14" D. C. .... **9.95**
- 12" A.C. 280 tube ..... **8.95**
- 11" D.C. 110 v. .... **4.95**
- 9" Midget ..... **3.49**

Baldwin

- 9" A.C. uses 280 tube .... **7.95**
- 9" D.C. with stand ..... **5.50**
- 9" D.C. less stand ..... **4.50**
- 9" Less output trans. .... **3.25**

Jensen

- Jr. Audit. with tube ..... **\$13.50**
- Concert Model AC D8 ..... **14.95**
- Concert Model DC D7 ..... **7.50**
- Concert Model DC D9 ..... **7.95**

**Amplion Single Button Micro. Very Sensitive**



**\$4.95**

**Farrand Inductor**



Unexcelled for tone quality. Requires no field current. Reproduces with dynamic quality.

- 9" ..... **\$6.95**
- 12" ..... **7.95**

**Flechthelm Meters**



- 0-300V DC ..... **\$1.95**
- 0-500V DC ..... **2.25**
- 0-600V AC & DC ..... **2.49**

**Best DeLuxe Theatre Pick-Up**



Build-in Vol. Control Price **\$7.25**

**R. C. A. Model**



- Model 106 AC with 280 tube rect. **\$12.50**
- Model 106 DC 300V Field with output trans. .... **5.50**
- Same as above, less trans. .... **4.50**
- Model 106 DC 110V field ..... **7.50**

**Try-Mo Radio Co., Inc.**

177 GREENWICH STREET,

NEW YORK CITY



# CROSLEY Electro Dynamic Speakers

FIRST TIME SOLD AT THIS PRICE

YOUR CHOICE **\$6.50** Net



- Model "A"—7" Chassis housed in beautiful metal cabinet Equipped with output transformer.
- Model "B"—Same as Model "A" Chassis only.
- Model "C"—9" Chassis with 900 ohm field and output transformer. Can be used with any set employing 1-171A or 1-245 power tube. Also can be used in Majestic Model 71.
- Model "D"—9" Chassis with 725 ohm field and push-pull output transformer.
- Model "E"—6 Volt Chassis for operation on storage battery or "A" eliminator. 85 ohm field and push-pull output transformer. Can be used with sets using the new 232 tubes. Can be converted for A.C. by use of a step-up transformer and 280 tube.

## CROSLEY TYPE F DYNACONE SPEAKER



This Crosley Speaker is meeting the increasing demand for an automobile radio reproducer which can be expected to give a full measure of satisfaction. Dynamic Tone!

OUR PRICE

**\$2.95** Net

### MUSIC MASTER Model "PETITE"

110 Volt A.C. 50-60 Cycle  
**THE SMALLEST**  
 17" x 13" x 7 1/2"  
**THE LIGHTEST**  
 Net 18 1/2 lbs. Ship'g. Weight 23 lbs.  
**THE MIGHTIEST**  
 in performance.



That, briefly describes this NATIONAL- LY and INTERNATIONALLY FAMOUS Midget Receiver. Made by a well known manufacturer. FULLY GUARANTEED to us and by us. The chassis is a masterpiece of compact radio engineering, sturdy, clean construction. Uses three 224 screen grid, one 245 Power and one Rectifier tubes, Loftin-White amplification, Electrolytic Condensers, Magnavox or Jensen Dynamic Speaker, and all housed in a beautiful Walnut Veneer Cabinet of graceful lines. The manufacturers' price is \$49.50 less usual trade discount.

OUR NET PRICE **\$25.45**

Optional: A set of good tubes supplied with each Receiver at \$1.25 additional. Convince yourself of the tremendous value of this offer. Order samples at once, examine and test them, your order for as many as you can handle will follow quickly.

### HARMONIC TELEVISION TUBES



These Television Tubes have been especially designed and manufactured to encourage television experiments among amateurs in this new field. HARMONIC Television Tubes are guaranteed to be perfect and they are priced extremely low.

1 1/2" Cathode Plate  
 1" Cathode Plate

OUR NET PRICE **\$3.90**

### A-B-C Power Pack

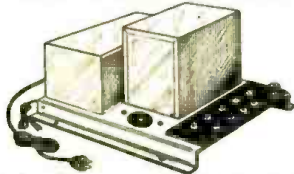

There are now available to the Service Man, experimenter, and custom set builder three models of power packs designed to supply "A," "B," and "C" potentials to radio receiver chassis of almost any type. Each pack is complete with voltage divider, filter condensers, filter choke, by-pass condensers, and taps for intermediate voltages (R.F., Detector, A.F., etc.). Two leads are provided for connection to a dynamic reproducer field; or the circuit may be completed through a filter choke supplied with each instrument, where the reproducer is a magnetic, or self-powered dynamic unit.

Each of these units is provided with taps supplying the usual R.F., detector, and A.F. voltages. These A.B.C. Power Units are going like hot-cakes! **\$6.75**

OUR PRICE FOR ANY TYPE



### Photoelectric Cells

These Photoelectric Cells are manufactured by one of the largest Eastern tube manufacturers. A large supply was purchased from them at a very low price and they are offered to you almost at cost. The tubes are perfect and guaranteed to give complete satisfaction in operating.

OUR NET PRICE **\$3.90**

### PENTODE ADAPTER

This Pentode Adapter permits the insertion of a type 247 Pentode Power Tube in place of the type 245 tube. Simply remove 245 tube, and insert the Adapter, and plug in the 247.

OUR NET PRICE **\$1.20**



### HARMONIC TUBES Guaranteed 6 Months

Every tube is carefully meter-tested before being shipped. Free replacement on any tube within 6 months provided they still light.

222	1.58	171	.79
210	1.58	112A	.69
250	1.58	200A	.69
281	1.58	199UV	.69
235	1.50	199UX	.69
247	1.50	120	.69
230	1.08	224	.69
231	1.08	226	.63
232	1.08	227	.63
245	.79	171A	.63
280	.79	201A	.63

### NIGHT HAWK SCREEN-GRID PENTODE RECEIVER CHASSIS

Right out of the laboratory steps this Screen-Grid and Pentode set! With the tremendous R.F. amplification of two Screen-Grid tubes, the remarkable sensitivity of a Screen-Grid detector, and the fine results obtainable only from a power Pentode, this remarkable set out-steps sets having many more tubes of earlier types.

It has such small dimensions as to be readily adaptable to mantel receiver design; or, it may be used in cabinets of larger size. Radio men should literally, "coin money" with this remarkable chassis.

OUR NET PRICE **\$14.50**

The Pentode Dynamic Reproducer designed especially for this set is obtainable at the special low price of \$4.25.

### JENSEN "CONCERT" D. C. ELECTRO DYNAMIC SPEAKERS

Model D7DC 10" Diameter  
 2500 ohm field 8 ohm voice coil

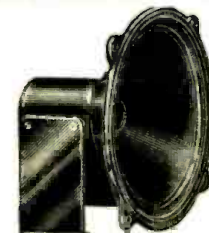

These units contain suitable push-pull transformers and are absolutely hum-free. Connect directly to the set, no outside wires.

As most standard manufactured A.C. sets are engineered for D.C. speakers of this ohmage, the possibilities for replacement with this really good speaker are practically unlimited.

The wise merchant or repair-man will take advantage of this real "buy". Never before offered at a cut price. The quantity available at this price is limited. Act quickly.

List \$27.50  
 OUR NET PRICE **\$7.90**  
 Original factory packing of 2 in a carton.

All offers are F.O.B. New York, and subject to prior sale. Terms: A deposit of 20% is required with every order. Balance may be paid on delivery. Or, deduct 2% if full amount is sent with order.

**DO NOT WRITE FOR CATALOG!**

**GRENPARK CO., Dept. RC, 245 Greenwich Street, New York, N.Y.**





# Prices YOU can make a REAL profit on!



## Famous Model "G" Gordon Phono-Motor and Turntable

First time at this price. Ruggedly constructed throughout. Spanish felt gears assure silence. Equipped with automatic stop control. Induction type, no brushes. Easy to install—exceptionally quick starting torque. For 110 volt 60 cycle alternating current. Proven dependability has made this New Gordon Electric Phonograph Motor and Turntable the accepted standard of excellence for the industry.



First time at this price. Make a nice profit and build good will with everyone.

List \$30.00  
**OUR PRICE \$8.95**

## Farrand Dynamic Chassis

Famed for its simplicity and reliability. Easily installed in all types of radio or phonograph consoles. Tonal range and fidelity superior to any other reproducing unit in general use. Dimension: Height 9 inches, width 8 3/4 inches, depth 7 inches. For A.C. current.

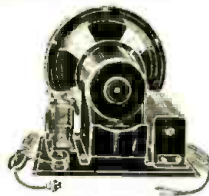

**OUR PRICE \$5.95**

## Condenser Block for Majestic "B" Eliminator



Replacement for defective blocks in "B" Eliminators—identical in electrical characteristics and outside dimensions. Can also be used in any make "B" Eliminator as well as most power packs

**OUR PRICE \$2.75**

## Gordon Acme 4 Pick-Up with Volume Control

Genuine Bakelite arm with beautiful natural wood finish will not show wear as will plated metal. Faithfully reproduces the entire musical range.

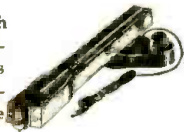

**OUR PRICE \$4.50**

**I.C.A. Test Leads**—a necessity to the dealer or serviceman. Unsurpassed for testing sets and tracing shorts, opens and other common defects. Easily attached to testing meter or electrical apparatus. **40c**

## R. C. A. Radiola Magnetic Chassis



Will stand up to 600 volts without distortion. Contains output transformer. Used in 100B, and 103 speakers. Outside diameter 9 in.; depth over all 4 1/2 in. Ideal for any radio installation. Complete with 5 ft. radio cord.

**OUR PRICE \$2.95**

## R. C. A. Loudspeaker 103

A beautiful speaker, superb in its faithful reproduction. Molded frame and pedestal resemble hand carved oak. Mechanism concealed by attractive tapestry.



(Genuine R.C.A.)  
List \$18.00

**OUR PRICE \$3.95**

## Atwater-Kent Condenser & Filter Block

For Model 37 and 38 Sets

Ideal filtering system for ANY make A. C. set using 171-A tube. Contains proper chokes and high voltage condensers. Flexible wire colored leads same as original.



### HOOK-UP

Green wire to 280, black to R.F. plate, yellow to Power Tube plate, white to first audio by-pass, white to C.T. of 226 resistance, red to detector **OUR PRICE** can to ground.

**\$2.95**

## Kolster K-6 Speaker

Magnetic type cone speaker. Remarkable tone quality; volume to spare. Beautifully carved, fine Walnut cabinet. Equipped with highly sensitive oversize magnet and driving unit. Faithful reproduction from the faintest whisper to fullest volume of a brass band.



List \$20.00

**OUR PRICE \$3.95**

## AIR-KING

### Superheterodyne S.W. Converter

The greatest converter ever built.

Brings in European stations clear as a bell. Converts any set into a short wave receiver. Employs 3-227 tubes; covers from 20 to 115 meters. Coil switch covers all wave lengths. Single dial control, no body capacity, no squeals. Has built-in filament transformer to heat the 3-227's. All you need from your receiver is a positive B. voltage from 17 to 180 volts. Voltage is not critical; no modulation of the receiver. Size 7x10x5 in. Weight 8 lbs.

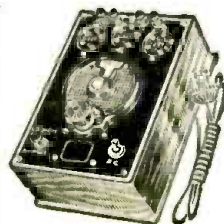

**OUR PRICE \$14.70**

## New Type Elkon Dry Disc Rectifier

Standard on "A" Eliminators for Majestic, Mayolian, Webster, Elkon, Bernard, Fada, Knapp, Sentinel, Metro, General Instrument, Philco (Elkon equipped) and also on Elkon 3 amp., and Briggs & Stratton chargers.

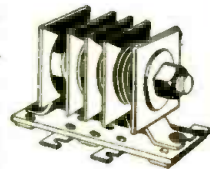

**OUR PRICE**

**\$3.45**

List \$7.00

## Baldwin Rival Unit



This Nathaniel Baldwin unit is one of the finest. For phonograph, automobile and portable radio outfits. We offer this famous unit now at a sensationally reduced price.

**OUR PRICE 50c**

## VICTOR ABC Power Transformer

For use with 6-226, 2-245, 1-227 and 1-280 tubes. Magnetically shielded preventing hum. Can safely be overloaded 30%. High voltages, 400 volts at 150 mls on either side of center tap. Extra large case especially designed to prevent overheating.

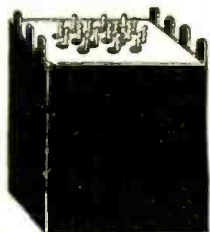

Can Be Used For Any Power Amplifier Using 245 Tubes

Size: 4 1/2 x 5 x 5 1/2 inches.  
No. 1—Center tap of 9 and 14 (5 volts).  
No. 2 and 4—2 1/2 Volts.  
No. 5 and 7—1 in. V. High amp. (226).  
No. 3 and 6—Primary (110V. input).  
No. 8—Center tap of 12 and 17 (2 1/2 V.)  
No. 9 and 14—5 Volts (280).  
No. 10 and 15—High voltage for B supply.  
No. 16—Center tap of above.  
No. 12 and 17—2 1/2 in. volts high amp. (224).

**OUR PRICE \$2.75**

## FREE Catalog—means money to you

These are only a few samples of the values to be found in our catalog. It is full of items on which you can make from 50% to 300% profit. And the best of them is, they are sound, well known, trademarked articles you can depend upon.

Send 20¢ with the order and articles will be shipped C.O.D. Order any of the above articles direct from this page. And be sure to ask for the catalog. It means money to you!

## RADIO CIRCULAR CO.

225 Varick St. New York City

**ORDER DIRECT... from this page!**

**TEAR IT OUT NOW!**

RADIO CIRCULAR CO., 225 Varick Street, New York City

Enclosed find \$..... This is 20% of items listed below. I will pay balance upon receipt of merchandise.

.....  
.....  
.....

Name.....

Address.....

Also please send catalog.

**Send for FREE catalog!**

RADIO CIRCULAR CO.  
225 Varick Street, New York City

Please send me your catalog of radio bargains I can make a profit on.

I understand this obligates me in no way.

Name.....

Address.....

City.....

State.....



# STOP SHOPPING!!

HERE'S a NEW plan, which saves you money. Stop shopping—the lowest prices are right on this page. Yes, lower than in our own catalog. Why? Because no house can get out a new catalog every month, but by advertising in this magazine we can bring

you the latest and lowest prices up to the time this ad is printed. We watch our competitors and do not allow anyone to undersell us. We meet ANY price on NEW merchandise. Order direct from this page and save money. 100% satisfaction on every transaction.

## NEW! NEW!

Several months ago we sent out a questionnaire to 2,000 radio service men and asked them what their ideas were on a radio service kit. 865 answered us, and their ideas are now embodied in the Official Radio Service Kit which we herewith present to you.

This kit is a marvel in compactness, a marvel in price, a marvel in time saving. For the first time you are offered a comprehensive kit that contains EVERYTHING that the service man requires in making calls.

### ARE YOU A 50 PER CENT SERVICE MAN?

Too often so-called service men go on a job with an analyzer and a half of pliers. Nine times out of ten they have to run back to the shop to get tools, and thus their usefulness is cut down, as a rule, 50% and over. Why not take along, on every job, a business-looking like service kit that looks just as business-like as your analyzer?

When you call upon a prospect and you arrive with this fine-looking kit, your prospect knows that you mean business. It gives you a professional appearance that every service man requires more than anything else today.

### AND YOU CAN COMMAND MORE MONEY ON YOUR SERVICE CALLS WITH THIS KIT

because the prospect will look upon you as a professional, and not as a tinkerer.

When you visit a medical specialist today, you are impressed by his instruments, for which you pay. An ordinary doctor commands no such fees. It should be clear to you that if you are a professional, you can get professional fees today too. That is why this marvelous kit will pay for itself inside of three months or less.

Herewith, are the Official Radio Service Kit specifications: Size, small and compact; not larger than a good analyzer; 17 in. long, 6 1/4 in. wide and 10 in. high. Construction, wood veneer throughout, entirely covered with black leatherette, all nickel trimmings, giving outfit a beautiful professional appearance.

There are two trays which lift out. Top tray contains the following:

## Official Radio Service Kit



**\$15.75**

Both felt lined trays are built to fit the tools and contents of kit. Everything ALWAYS in place. No hunting for this or that item. Neat. Efficient.

- 1 Pen Flashlight, complete with magnifying dentist's mirror (to look underneath chassis, etc.)
- 1 Automatic alcohol blow torch.
- 1 Box containing 300 assorted screws, nuts, washers, lugs, etc.
- 1 Nickel Bicycle wrench.
- 1 Tap holder with one 6/32 tap and one 8/32 tap.
- 1 Set of Test prods, with 6 ft. cord.
- 1 Telephone type pliers.
- 1 Diagonal pliers.
- 1 Insulated 45,000 volt insulated handle heavy pliers.
- 1 Electrician's knife.
- 1 Set of 8 drill points.
- 10 Ft. of Phosphor bronze drum dial cable.
- 1 Neutralizing socket.
- 1 Pack extra size pipe cleaners (to clean condensers).
- 3 Small screw drivers.

- Lower tray contains:
- 1 Complete Neutralizing kit with insulated screw driver and five socket wrenches.
  - 1 Electric soldering iron, with 1 extra tip.
  - 1 Large and 1 Medium imported screw drivers.
  - 2 Small files with handles.
  - 1 Large file with handle.
  - 1 1/2 in. Star drill, 1 1/2 in. long.
  - 1 Hand drill, 1/2 in. chuck, 10 in. long.
  - 1 Electrician's metal hammer.
  - 1 Hack saw and blade.
  - 1 Package Sand papers and emery papers.
  - 1 Roll 50 ft. solid push back wire.
  - 1 Can genuine Kester radio solder.
  - 1/2 lb. of 3/4 in. electrician's tape.
  - 1 Bottle Furniture polish.
  - 1 Package Furniture cheese-cloth.
  - 1 Bottle Nujol (for lubricating purposes).
  - 1 Tube steeal cement (to mend cones, etc.)
  - 1 Socket tool to straighten socket prongs.

## NEW! NEW!

### IMPORTANT!

There is sufficient room in the bottom of the kit to place the Official Radio Service Manual, as well as other data sheets (but at the price quoted Manual is not included).

Both trays, as well as inside cover, are lined with blue felt, giving kit a beautiful appearance.

Nothing similar has ever been offered before. Only by buying the various materials in tremendous quantities are we enabled to sell this kit at such an extremely low price.

If you were to buy all of the articles separately, in the open market, you would have to pay between \$30.00 and \$35.00 for them.

Due to the present depression, we are enabled to buy quantities of these materials at exceedingly low prices. For that reason, our production cost is exceedingly low, but there is no question that this price will have to be increased later.

Size, 17 in. long, 6 1/4 in. wide and 10 in. high; net weight, 16 lbs.; shipping weight, 18 lbs.

No. 1000—Official Radio Service Kit—Your price..... **\$15.75**

### CARRYING CASE

We are prepared to furnish you with the Official Radio Service Case only, without contents, as described above, but the case and the two empty trays, size 17 in. long, 6 1/4 in. wide and 10 in. high.

This case is made entirely of light veneered wood, nickel trimmings, covered entirely with leatherette. Inside of case covered in blue felt.

Net weight, 4 lbs. Shipping weight, 5 lbs.

No. 1001—Official Radio Service Carrying Case only, your price..... **\$4.85**



View of kit, closed.

### RADIO CARRYING CASES

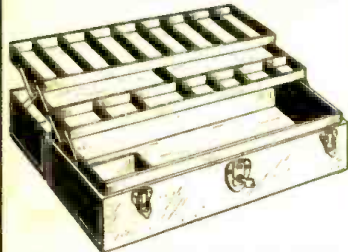

The cases here shown are a new development. They are made in metal throughout with baked olive green enamel finish. These cases are beautifully and strongly made, and will give you a professional appearance. Lock and slide locks are of burnished brass.

The smaller illustration shows dimensions and closed view of the cases. As you open the cover, two trays automatically fold out in position, as shown. As you tilt the cover back, the trays fold automatically into the case. The trays are provided with a number of compartments for tools and all other radio appliances that you may wish to carry. The large box accommodates about eight radio tubes in the bottom compartment. The smaller case accommodates about four tubes.

Cases are strong and rugged, and when closed, nothing can spill. They are marvels of ingenuity, and will pay for themselves many times over.

Large size measures 21 1/2 in. long, 7 1/4 in. high and 7 in. wide. Net weight 8 lbs. Shipping weight 10 lbs. List price \$8.50. No. 1002—Carrying Case, your price..... **\$4.75**

### SMALL CARRYING CASE

This case is in all respects the same as the one described above, except that the dimensions are less, otherwise the same in all respects.

Size 12 1/2 in. long, 7 1/4 in. high and 7 in. wide. Net weight, 5 lbs.; shipping weight, 6 lbs. List price, \$6.50. No. 1003—Carrying Case—Your Price..... **\$3.45**

## NEW! NEW!!

### Superheterodyne S-W Converter

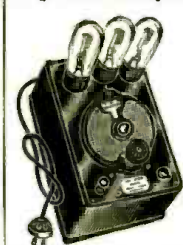

At last a short-wave converter that converts any broadcast set into a superheterodyne short-wave receiver. Employs three 22T tubes and covers from 20 to 115 meters. No plug-in coils! Coil switch is used to cover all wavelengths. Single dial control. No body capacity, no squeals. This converter has built-in filament transformer to heat the three 22T's.

All you need to obtain from your receiver is a positive B voltage anywhere from 45 to 180 volts. Voltage is not critical; no modulation of the receiver. So simple a child can operate it. Size 7 x 10 x 5 inches. Shipping weight, 8 lbs. List Price \$25.00.

No. 1614—Super Converter (less tubes). YOUR PRICE..... **\$14.69**

## World-Wide Short-Wave Set NOT A CONVERTER

### NEW

A perfect radio short-wave receiver for use between 17 and 84 meters. To put into operation, connect antenna, ground, 45-volt "B," and 6-volt "A" batteries, and headphones to the posts provided, plug in a type 01A tube, and tune in! An ingenious circuit makes possible a 4-coil single-winding plug-in design. This little instrument has the same sensitivity as many big shielded short-wave receivers costing ten times as much. A power amplifier may be added for any degree of volume. Complete with 4 plug-in coils. Has fine vernier dial for precision tuning. Never has a first class short-wave set sold for so little money. This short-wave set measures 5 1/2 x 7 1/4 in. high, over all. Ship. weight, 3 lbs. List price, \$12.50.

No. 1666—World-Wide S.-W. Set. **\$6.25** Your price.....



## New 36 page Summer Edition No. 23



75 New Hook-Ups, etc., 350 Illustrations.

The new Summer Edition of our greatly enlarged RADIO SERVICE TREATISE has just come off the press. If you liked the Winter Issue, you will like this one a hundred-fold. It contains some 75 new hook-ups, circuit diagrams, and some 350 illustrations. POSITELY THE GREATEST BOOK EVER PUT OUT BY ANYONE. Among the new matters listed are:

VACUUM TUBE TREATISE, with many illustrations, full page Vacuum Tube Average Characteristics Chart; How to Take Care of Your Tubes; How to Connect Phonograph Pick-ups; Improving the Tone Quality of Old Sets; Connecting Additional Loud Speakers; all fully illustrated with diagrams.

Other articles: Modernizing Old Radio Sets; How to Convert Battery to Power Sets; Selection of Tubes; Push-Pull Amplifiers; Replacing Audio Transformers; Phono Attachments; How to Choose Power Transformers; Voltage Dividers; Wattage of Power Transformers; Selecting and Installing Replacement Parts in Radio Sets; Filter Condensers; Repairing Eliminators.

WRITE TODAY. Enclose 2 cents for postage. Treatise sent by return mail.

WE ARE A WHOLESALE HOUSE AND CANNOT ACCEPT ORDERS FOR LESS THAN \$3.00.

If C. O. D. shipment is desired, please remit 20% remittance, which must accompany all orders.

If full cash accompanies order, deduct 2% discount. Send money order—certified check—U. S. stamps.

**Radio Trading Co.**  
23 West Broadway  
New York, N. Y.

ORDER FROM THIS PAGE. You will find special prices from time to time in this magazine. Get our big FREE catalog for the greatest Radio Bargains.

Should you wish goods shipped by parcel post, be sure to include sufficient extra remittance for same. Any excess will be refunded.

### High-Voltage Condenser Units

We guarantee these condensers unconditionally. They are ideal for general replacement purposes and can be installed in any new power-pack. All condensers are furnished with 8-inch lengths of tinned "push-back" wire.

600 VOLTS			800 VOLTS		
Cat.	Mfd.	Your Price	Cat.	Mfd.	Your Price
1702	1/2	\$0.25	1706	1	\$0.40
1703	1	.30	1707	2	.70
1704	2	.40	1708	4	1.05
1705	4	.60			





*“and these Apartments are all wired for Radio — you’re sure of ideal radio reception through the **RCA Antenaplex System**”*

One perfect antenna on the roof, and radio outlets all through the building for the convenience of the tenants. Just plug in your set, and it’s ready to work. You get better reception this way than with separate antenna wires,—clean signals, minus the usual local interference from electrical devices throughout the house.

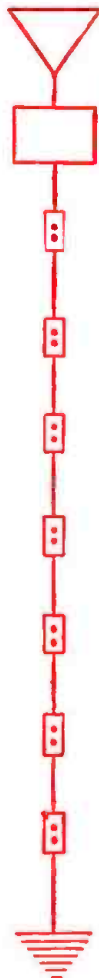

## Attention! RADIO SERVICE MEN

The RCA Antenaplex System solves the apartment house radio problem, delivering 100% of antenna signal energy to every outlet. The lead covered cable may be run exposed, concealed, or in metal conduit.

An attractive proposition awaits Radio Service men and electrical contractors who want to promote sales and install this equipment in new or existing structures.

Write for information and illustrated instructions.

ENGINEERING PRODUCTS DIVISION

RCA Victor Company, Inc.

Camden, New Jersey

A Radio Corporation of America Subsidiary



Centralized Radio Systems

# SM

## The Finest Radio Receiver in the World

### 716 Tuner and 683 Amplifier

For three consecutive years past, the Silver-Marshall 710, 712 and 714 broadcast tuners have been outstandingly the finest money could buy. And now comes the 716, finer than all its famed predecessors, and giving an order of sensitivity, selectivity and tone never before approached—even by Silver-Marshall engineers.

Over a short period of time the 716 and 683 combination should log nearly every station in the Call Book. Seventy stations in twenty minutes is no trick at all.

In the 716, two tuned circuits precede the first '51 r.f. tube, utilized in such a manner that their effective selectivity is actually greater than that of the previous 714 tuner. A third tuned circuit is before the '24 first detector and the fourth in the '27 oscillator circuit. All coils and the special gang condenser (which gives unusually great dial separation between low-wave stations for these four circuits) are shielded to prevent radiation and unwanted pickup. The two-stage i.f. amplifier uses '51 tubes and three-impedance or dual-tuned transformers, of extreme selectivity, feeding into the '27 second linear power detector.

The 683 Amplifier employs a totally new and revolutionary dual tone control system by means of which the treble or bass can be raised at will, leveled off, or lowered, independently of each other. This, with the 716 tuner, results in a clarity of both speech and music at high or low volumes never before attained in any radio.

If you want the finest receiver that money can buy, this combination is what you are looking for.

Tubes required: 3—'51's, 2—'27's, 1—'24.

### 716 Vario-Mu Superhet Tuner

The 716 tuner as described above, completely factory wired, tested and RCA licensed. Size 16½" long, 10½" deep (exclusive of controls) 7¾" high. Shipping weight 25 lbs. .... Price \$69.50 LIST

### 683 Push-Pull Pentode Amplifier

The 683 amplifier is intended primarily for use with the 716 Tuner. Supplies required B, C and heater currents. Designed to use with 855B Speaker (800 ohm field). Tubes required: 1—'27, 2—'47's, 1—'80. Size 12" long, 9½" deep, 9" high. Factory wired and tested, RCA licensed ..... Price \$69.50 LIST

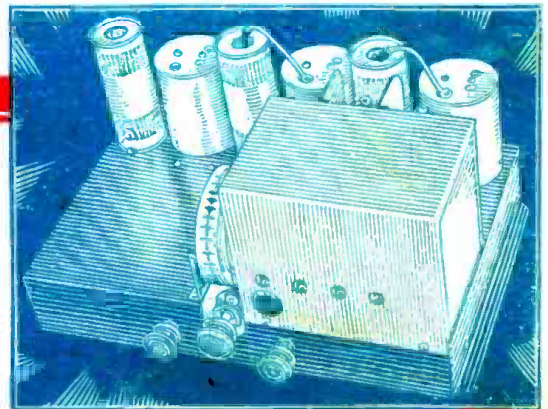

716 Tuner Only

### Engineering Features

10-Tube Superheterodyne

3 New Vario-Mu Tubes

2 Push-Pull Pentode Tubes

Sensitivity of Less than One-Half  
Microvolt per Meter

Absolute 10-Kilocycle Separation

Two Separate Tone-Controls

Double-Unit Construction

An Analyzed, Developed, Per-  
fected Stenode Radiostat Prin-  
ciple of Side-Band Attenuation  
Coupled with Audio Compensa-  
tion, is employed.

### Write for *New* General Parts Catalog

SILVER-MARSHALL, Inc. Dept. R-C 3  
6419 W. 65th Street, Chicago, U. S. A.

Please send me full details on the S-M 716 and 683  
(enclosed you will find 2c).

Please send me FREE your new General Parts  
Catalog.

Name .....

Address .....

The new Catalog gives detailed data on a complete new line of chassis, kits, amplifiers, replacement parts, etc. Everything from a short-wave converter without plug-in coils, to a new line of transformers.

**SILVER-MARSHALL, Inc.**  
6419 West 65th Street • Chicago, U. S. A.  
Canadian Division: SILVER-MARSHALL of CANADA, Ltd.  
75 Sherbourne Street, Toronto